

Nomadic Communications Labs



Alessandro Villani
avillani@science.unitn.it



WireShark **(Previously ethereal)**

WireShark

- ❑ WireShark is a network packet analyzer completely open source
- ❑ Available at the address:
<http://www.wireshark.org/>
- ❑ It can decode a lot of protocols, including:
 - IEEE 802.11 wireless LAN
 - Radius
 - 802.1x Authentication
- ❑ Wireshark is a nice network analyzer, but if you plan to dump a lot of packets use tcpdump

WireShark: filtering when capturing

- A “capture filter” has the form of a series of primitive expressions connected by connections (**and/or**) and possibly preceded by a **not**:

[not] **primitive** [and|or [not]
primitive ...]

- For examples:

tcp port 23 and host 193.205.194.23

tcp port 23 and not host 193.205.194.23

WireShark: filtering when capturing

- ❑ **Some of the most used primitives:**
- ❑ **[src|dst] host <host>**
 - This primitive allows to filter on the basis of the IP address or the name of the host
- ❑ **ether [src|dst] host <ehost>**
 - This primitive allows to filter on the basis of the ethernet address of the host
- ❑ **[src|dst] net <net> [{mask <mask>}|{len <len>}]**
 - This primitive allows to filter on the basis of the network addresses
- ❑ **[tcp|udp] [src|dst] port <port>**
 - This primitive allows to filter on the basis of the TCP and UDP port numbers
- ❑ **ip|ether proto <protocol>**
 - This primitive allows to filter on the basis of the protocols specified at Ethernet or IP level



Promiscuous Mode and Monitor Mode

Promiscuous Mode

- ❑ To make *sniffing* on a network device it is required that the filter based on the MAC address in the destination field applied to the incoming packets is deactivated: promiscuous mode
- ❑ In most cases the control is not hardcoded and therefore it is possible to disabled it acting on the driver

Monitor Mode

- ❑ For many 802.11 wireless cards, besides the *Promiscuous Mode*, it is possible to use another mode: the *Monitor Mode*
- ❑ This mode allows to make sniffing in a completely passive way: we can see all what is on the wireless channel without having to join to the WLAN (it is not possible to transmit, but the card can be used more efficiently for listening)
- ❑ The possibility of using a card in Monitor Mode depends on the driver

Monitor Mode

- A (not complete) list of cards, with the corresponding linux driver which support the Monitor Mode, is available at the address:

<http://www.kismetwireless.net/documentation.shtml>



Analysis of 802.11 Packets

BackTrack

- We will use a Linux Live distribution: BackTrack
 - <http://www.backtrack-linux.org/>
- It has all the tools we need for wireless sniffing and monitoring, and we don't need to install any program on the laptop or ask for root password

BackTrack: Startup

- ❑ Currently we can use two different versions: *V3.0 Final* or *V:4.0 Beta*
- ❑ For *Version 3.0 Final*
 - Boot from CD (`BT3 Graphics mode`)
- ❑ For *Version 4.0 Final*
 - Boot from DVD (`Text mode`)
 - Login as root:
 - ❑ Login: `root`
 - ❑ Password: `toor`
 - Start the graphics mode:
 - ❑ `startx`

BackTrack: iwconfig

- ❑ To get the Wireless Network Card parameters:

- iwconfig

- ❑ The result is something like:

```
eth0      IEEE 802.11b  ESSID:"science-wifi"  
Mode:Managed  Frequency:2.462 GHz  Access Point: 00:40:96:5E:0D:64  
Bit Rate:11 Mb/s  Tx-Power=20 dBm  Sensitivity=8/0  
Retry limit:7  RTS thr:off  Fragment thr:off  
Encryption key:off  
Power Management:off  
Link Quality=46/100  Signal level=-73 dBm  Noise level=-88 dBm  
Rx invalid nwid:0  Rx invalid crypt:0  Rx invalid frag:0  
Tx excessive retries:0  Invalid misc:34  Missed beacon:0
```

BackTrack: iwconfig

- ❑ To put the wireless Network Card in monitor mode (listening the channel 7):

- `iwconfig eth0 mode monitor channel 7`

- ❑ If we give the `iwconfig` command again, the result is something like:

```
eth0          unassociated  ESSID:off/any
Mode:Monitor  Frequency=2.442 GHz  Access Point: Not-Associated
Bit Rate:0 kb/s  Tx-Power=20 dBm  Sensitivity=8/0
Retry limit:7  RTS thr:off  Fragment thr:off
Encryption key:off
Power Management:off
Link Quality:0  Signal level:0  Noise level:0
Rx invalid nwid:0  Rx invalid crypt:0  Rx invalid frag:0
Tx excessive retries:0  Invalid misc:51  Missed beacon:0
```



802.11 Frames

802.11 Frame

- ❑ The Monitor Mode (plus applications like WireShark or Kismet) allows us to analyze the frames of a 802.11 communication
- ❑ 802.11 defines several types of frame which stations (NIC and AP) use to communicate among them and to manage and check the wireless link

802.11 Frame

- ❑ Each frame has a control field that defines the version of the 802.11 protocol, the type of frame, and several flags like if WEP is active, if the management power is active, ...
- ❑ Every frame contains MAC addresses of the source and destination station, a frame number, the frame body and a frame check (for error control)

802.11 Frame

□ Frame format:

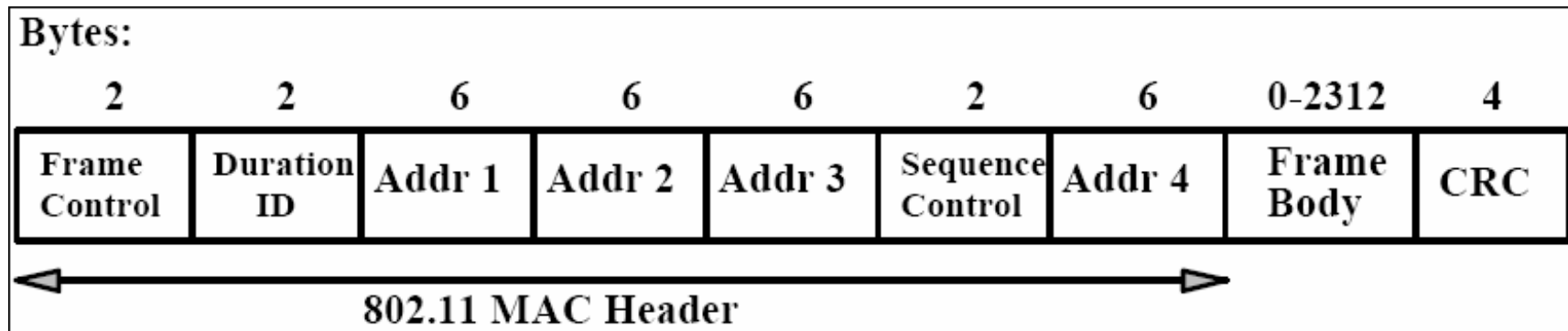

□ The Frame Control Field is:

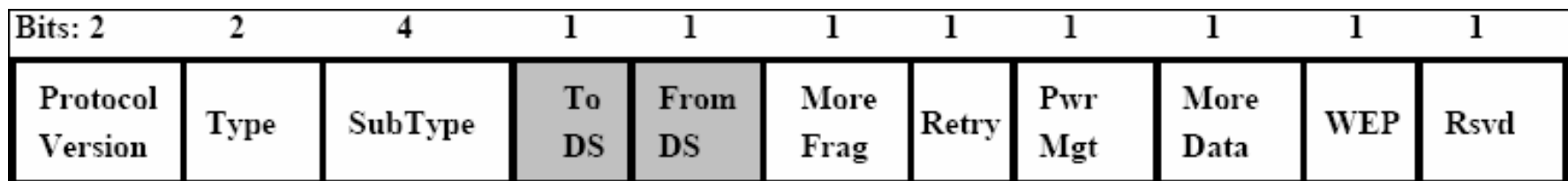

Frame Control Field

802.11 Frame: Management

□ Management Frame

Type Value	Type Description	Subtype Value	Subtype Description
00	Management	0000	Association Request
00	Management	0001	Association Response
00	Management	0010	Reassociation Request
00	Management	0011	Reassociation Response
00	Management	0100	Probe Request
00	Management	0101	Probe Response
00	Management	0110-0111	Reserved
00	Management	1000	Beacon
00	Management	1001	ATIM
00	Management	1010	Disassociation
00	Management	1011	Authentication
00	Management	1100	Deauthentication
00	Management	1110-1111	Reserved

802.11 Frame: Control

□ Control Frame

Type Value	Type Description	Subtype Value	Subtype Description
01	Control	0000-1001	Reserved
01	Control	1010	PS-Poll
01	Control	1011	RTS
01	Control	1100	CTS
01	Control	1101	ACK
01	Control	1101	CF End
01	Control	1111	CF End + CF-ACK

802.11 Frame: Data

□ Data Frame

Type Value	Type Description	Subtype Value	Subtype Description
10	Data	0000	Data
10	Data	0001	Data + CF-Ack
10	Data	0010	Data + CF-Poll
10	Data	0011	Data + CF-ACK + CF-Poll
10	Data	0100	Null Function (no data)
10	Data	0101	CF-Ack (no data)
10	Data	0110	CF-Poll (no data)
10	Data	0111	CF-Ack + CF-Poll (no data)
10	Data	1000-1111	Reserved

802.11 Frame: Management

- **Management Frames:** they allow to establish and keep the communications. For instance:
 - **Authentication Frame:** NIC begins the authentication process sending to the AP an *authentication frame* containing its identity:
 - Open system: NIC sends an authentication frame, and AP answers with an authentication frame containing the indication of success or failure
 - Shared key: NIC initially sends an authentication frame, and AP answers with an authentication frame containing a challenge. NIC must send an encrypted version of challenge (using the WEP key) in an authentication frame

802.11 Frame: Management

- **Deauthentication frame**
- **Association request frame:** Allows the AP to allocate resources for the NIC.
A NIC begins the association process sending an *association request frame* to an AP. This frame holds information about NIC (for instance the data rates supported) and the SSID of the WLAN it is associating
- **Association response frame:** An AP sends a *association response frame* containing a notification of acceptance or rejection of the NIC request of association. If AP accepts the NIC, the frame includes information like the association ID and the supported rates

802.11 Frame: Management

- **Beacon frame:** The AP periodically sends a *beacon frame* to announce his presence and send information, like timestamp, SSID, and other parameters regarding the AP itself
- **Probe request frame:** A station sends a *probe request frame* when it needs to obtain information from another station
- **Probe response frame:** A station will answer with a *probe response frame*, containing information like the supported speeds, after it has received a *probe request frame*

802.11 Frame: Control

- **Control Frames:** used in the delivery of frames data among the stations. For instance:
 - **Request to Send (RTS) frame**
 - **Clear to Send (CTS) frame**
 - **Acknowledgement (ACK) frame:** after the arrive of a data frame, the receiving station will use an error checking process and will send an *ACK frame* to the transmitting station if there are not mistakes. If the transmitting station does not receive an ACK after a certain time it will resend the data frame

802.11 Frame: Data

- **Data Frames:** The data frame contains inside the frame body the packets from the highest levels, as web pages, control information for the printers, ...,

802.11 Frame: Frame Control Field

□ **ToDS:**

- This bit is set to 1 when the frame goes to the AP for the forwarding to the DS (*Distribution System*)
- The bit is set to 0 in all other cases

□ **FromDS:**

- This bit is set to 1 when the frame is received from the DS
- The bit is set to 0 in all other cases, i.e., for frames that do not leave the BSS

802.11 Frame: Frame Control Field

□ **More Fragments:**

- This bit is to 1 when there are more fragments belonging to the same data packet following the current frame

□ **Retry:**

- This bit means that this frame is the retransmission of a frame previously transmitted. It is used by the receiving station to be aware of retransmission due to ACK loss

□ **Power Management:**

- This bit shows the Power Management behavior of the station after the transmission of this frame

802.11 Frame: Frame Control Field

□ **More Data:**

- This bit is used for the Power Management to specify that there are still frames for the station in the buffer. The station can decide to use the information to continue the polling or to switch in Active Mode.

□ **WEP:**

- This bit means that the frame body is encrypted with WEP

□ **Order:**

- This bit means that the frame is sent using a *Strictly-Ordered service class*

802.11 Frame: Frame Control Field

□ **Duration/ID:**

- This field has two meanings according to the type of frame :
 - In a Power-Save Poll message it corresponds to the Station ID
 - In all the other frames this is the duration used for the calculation of NAV

□ **Sequence Control:**

- This field is used to represent the order of various fragments belonging to the same packet and identify duplicate frames.
It consists of two subfields: *Fragment Number* and *Sequence Number*

802.11 Frame: Frame Control Field

□ **Address Fields:**

- A frame can contain up to 4 addresses based on the value of ToDS and FromDS bits:
 - **Address-1** it is always the receiver address.
If ToDS is set to 1 then it is the address of AP, otherwise it is the address of the final station
 - **Address-2** it is always the transmitter address.
If FromDS is set to 1 then it is the address of AP, otherwise it is the address of the final station
 - **Address-3** If FromDS is set to 1, Address-3 is the original source address, if ToDS is set to 1 then Address 3 is the destination address, otherwise it is the address of the AP in IBSS
 - **Address-4** is used when a Wireless Distribution System is used and the frame is transmitted by an AP to another

802.11 Frame: MAC Header

□ Address Fields:

To DS	From DS	Address 1	Address 2	Address 3	Address 4
0	0	DA	SA	BSSID	N/A
0	1	DA	BSSID	SA	N/A
1	0	BSSID	SA	DA	N/A
1	1	RA	TA	DA	SA

- **SA = Source MAC Address**
- **DA = Destination MAC Address**
- **TA = Transmitter MAC Address**
- **RA = Receiver MAC Address**
- **BSSID = AP MAC Address or Random MAC in Ad-Hoc**

802.11 Frame: Frame Format

- **CRC**: it is a field of 32-bits for the error checking, Cyclic Redundancy Check (CRC)



Beacon and Probe Frame

Beacon Frame – Part 1

```
Frame 1 (98 bytes on wire, 98 bytes captured)
  Arrival Time: Apr  7, 2005 23:30:17.202927000
  Time delta from previous packet: 0.000000000 seconds
  Time since reference or first frame: 0.000000000 seconds
  Frame Number: 1
  Packet Length: 98 bytes
  Capture Length: 98 bytes
  Protocols in frame: wlan
IEEE 802.11
  Type/Subtype: Beacon frame (8)
  Frame Control: 0x0080 (Normal)
    Version: 0
    Type: Management frame (0)
    Subtype: 8
    Flags: 0x0
      DS status: Not leaving DS or network is operating in AD-HOC mode (To DS: 0
From DS: 0) (0x00)
      .... .0.. = More Fragments: This is the last fragment
      .... 0... = Retry: Frame is not being retransmitted
      ...0 .... = PWR MGT: STA will stay up
      ..0. .... = More Data: No data buffered
      .0.. .... = WEP flag: WEP is disabled
      0... .... = Order flag: Not strictly ordered
  Duration: 0
  Destination address: ff:ff:ff:ff:ff:ff (Broadcast)
  Source address: 00:40:96:5e:0d:64 (AironetW_5e:0d:64)
  BSS Id: 00:40:96:5e:0d:64 (AironetW_5e:0d:64)
  Fragment number: 0
  Sequence number: 1394
```

Beacon Frame – Parte 2

IEEE 802.11 wireless LAN management frame

Fixed parameters (12 bytes)

Timestamp: 0x0000000007AC11AC

Beacon Interval: 0.102400 [Seconds]

Capability Information: 0x0021

....1 = ESS capabilities: Transmitter is an AP

....0. = IBSS status: Transmitter belongs to a BSS

.... 00.. = CFP participation capabilities: No point coordinator

at AP (0x0000)

....0 = Privacy: AP/STA cannot support WEP

....1. = Short Preamble: Short preamble allowed

....0.. = PBCC: PBCC modulation not allowed

.... 0... = Channel Agility: Channel agility not in use

.... .0.. = Short Slot Time: Short slot time not in use

..0. = DSSS-OFDM: DSSS-OFDM modulation not allowed

Tagged parameters (62 bytes)

Tag Number: 0 (SSID parameter set)

Tag length: 5

Tag interpretation: WILMA

Tag Number: 1 (Supported Rates)

Tag length: 4

Tag interpretation: Supported rates: 1.0(B) 2.0(B) 5.5(B) 11.0(B) [Mbit/sec]

Beacon Frame – Part 3

Tag Number: 3 (DS Parameter set)
Tag length: 1
Tag interpretation: Current Channel: 13
Tag Number: 5 ((TIM) Traffic Indication Map)
TIM length: 4
DTIM count: 1
DTIM period: 2
Bitmap Control: 0x00 (mcast:0, bitmap offset 0)
Tag Number: 7 (Country Information)
Tag length: 6
Tag interpretation: Country Code: EU, Unknown (0x00) Environment, Start
Channel: 1, Channels: 13, Max TX Power: 50 dBm
Tag Number: 133 (Cisco Unknown 1 + Device Name)
Tag length: 30
Tag interpretation: Unknown + Name: Cisco 350 - VVM

Probe Request – Part 1

```
Frame 2 (37 bytes on wire, 37 bytes captured)
  Arrival Time: Apr  7, 2005 23:30:17.272964000
  Time delta from previous packet: 0.070037000 seconds
  Time since reference or first frame: 0.070037000 seconds
  Frame Number: 2
  Packet Length: 37 bytes
  Capture Length: 37 bytes
  Protocols in frame: wlan
IEEE 802.11
  Type/Subtype: Probe Request (4)
  Frame Control: 0x0040 (Normal)
    Version: 0
    Type: Management frame (0)
    Subtype: 4
    Flags: 0x0
      DS status: Not leaving DS or network is operating in AD-HOC mode (To DS: 0
From DS: 0) (0x00)
      .... .0.. = More Fragments: This is the last fragment
      .... 0... = Retry: Frame is not being retransmitted
      ...0 .... = PWR MGT: STA will stay up
      ..0. .... = More Data: No data buffered
      .0.. .... = WEP flag: WEP is disabled
      0... .... = Order flag: Not strictly ordered
  Duration: 0
  Destination address: ff:ff:ff:ff:ff:ff (Broadcast)
  Source address: 00:0b:cd:8d:30:3b (172.31.194.10)
  BSS Id: ff:ff:ff:ff:ff:ff (Broadcast)
  Fragment number: 0
  Sequence number: 2
```

Probe Request – Part 2

IEEE 802.11 wireless LAN management frame

Tagged parameters (13 bytes)

Tag Number: 0 (SSID parameter set)

Tag length: 5

Tag interpretation: WILMA

Tag Number: 1 (Supported Rates)

Tag length: 4

Tag interpretation: Supported rates: 1.0 2.0 5.5 11.0 [Mbit/sec]

Probe Response – Part 1

```
Frame 4 (84 bytes on wire, 84 bytes captured)
  Arrival Time: Apr  7, 2005 23:30:17.281343000
  Time delta from previous packet: 0.001169000 seconds
  Time since reference or first frame: 0.078416000 seconds
  Frame Number: 4
  Packet Length: 84 bytes
  Capture Length: 84 bytes
  Protocols in frame: wlan
IEEE 802.11
  Type/Subtype: Probe Response (5)
  Frame Control: 0x0050 (Normal)
    Version: 0
    Type: Management frame (0)
    Subtype: 5
    Flags: 0x0
      DS status: Not leaving DS or network is operating in AD-HOC mode (To DS: 0
From DS: 0) (0x00)
      .... .0.. = More Fragments: This is the last fragment
      .... 0... = Retry: Frame is not being retransmitted
      ...0 .... = PWR MGT: STA will stay up
      ..0. .... = More Data: No data buffered
      .0.. .... = WEP flag: WEP is disabled
      0... .... = Order flag: Not strictly ordered
  Duration: 314
  Destination address: 00:0b:cd:8d:30:3b (172.31.194.10)
  Source address: 00:40:96:5e:0d:64 (AironetW_5e:0d:64)
  BSS Id: 00:40:96:5e:0d:64 (AironetW_5e:0d:64)
  Fragment number: 0
  Sequence number: 1397
```

Probe Response – Part 2

IEEE 802.11 wireless LAN management frame

Fixed parameters (12 bytes)

Timestamp: 0x0000000007AD44C3

Beacon Interval: 0.102400 [Seconds]

Capability Information: 0x0021

....1 = ESS capabilities: Transmitter is an AP

....0. = IBSS status: Transmitter belongs to a BSS

.... 00.. = CFP participation capabilities: No point coordinator
at AP (0x0000)

....0 = Privacy: AP/STA cannot support WEP

....1. = Short Preamble: Short preamble allowed

....0.. = PBCC: PBCC modulation not allowed

.... 0... = Channel Agility: Channel agility not in use

.... .0.. = Short Slot Time: Short slot time not in use

..0. = DSSS-OFDM: DSSS-OFDM modulation not allowed

Tagged parameters (48 bytes)

Tag Number: 0 (SSID parameter set)

Tag length: 5

Tag interpretation: WILMA

Tag Number: 1 (Supported Rates)

Tag length: 4

Tag interpretation: Supported rates: 1.0(B) 2.0(B) 5.5(B) 11.0(B) [Mbit/sec]

Tag Number: 3 (DS Parameter set)

Tag length: 1

Tag interpretation: Current Channel: 13

Tag Number: 133 (Cisco Unknown 1 + Device Name)

Tag length: 30

Tag interpretation: Unknown + Name: Cisco 350 - VVM



Authentication

Authentication Request – Part 1

Frame 10 (30 bytes on wire, 30 bytes captured)

Arrival Time: Apr 7, 2005 23:30:17.510590000

Time delta from previous packet: 0.000479000 seconds

Time since reference or first frame: 0.307663000 seconds

Frame Number: 10

Packet Length: 30 bytes

Capture Length: 30 bytes

Protocols in frame: wlan

IEEE 802.11

Type/Subtype: Authentication (11)

Frame Control: 0x00B0 (Normal)

Version: 0

Type: Management frame (0)

Subtype: 11

Flags: 0x0

DS status: Not leaving DS or network is operating in AD-HOC mode (To DS: 0
From DS: 0) (0x00)

.... .0.. = More Fragments: This is the last fragment

.... 0... = Retry: Frame is not being retransmitted

...0 = PWR MGT: STA will stay up

..0. = More Data: No data buffered

.0.. = WEP flag: WEP is disabled

0... = Order flag: Not strictly ordered

Duration: 258

Destination address: 00:40:96:5e:0d:64 (AironetW_5e:0d:64)

Source address: 00:0b:cd:8d:30:3b (172.31.194.10)

BSS Id: 00:40:96:5e:0d:64 (AironetW_5e:0d:64)

Fragment number: 0

Sequence number: 13

Authentication Request – Part 2

IEEE 802.11 wireless LAN management frame

Fixed parameters (6 bytes)

Authentication Algorithm: Open System (0)

Authentication SEQ: 0x0001

Status code: Successful (0x0000)

Authentication Replay – Part 1

Frame 11 (30 bytes on wire, 30 bytes captured)

Arrival Time: Apr 7, 2005 23:30:17.513426000

Time delta from previous packet: 0.002836000 seconds

Time since reference or first frame: 0.310499000 seconds

Frame Number: 11

Packet Length: 30 bytes

Capture Length: 30 bytes

Protocols in frame: wlan

IEEE 802.11

Type/Subtype: Authentication (11)

Frame Control: 0x00B0 (Normal)

Version: 0

Type: Management frame (0)

Subtype: 11

Flags: 0x0

DS status: Not leaving DS or network is operating in AD-HOC mode (To DS: 0
From DS: 0) (0x00)

.... .0.. = More Fragments: This is the last fragment

.... 0... = Retry: Frame is not being retransmitted

...0 = PWR MGT: STA will stay up

..0. = More Data: No data buffered

.0.. = WEP flag: WEP is disabled

0... = Order flag: Not strictly ordered

Duration: 258

Destination address: 00:0b:cd:8d:30:3b (172.31.194.10)

Source address: 00:40:96:5e:0d:64 (AironetW_5e:0d:64)

BSS Id: 00:40:96:5e:0d:64 (AironetW_5e:0d:64)

Fragment number: 0

Sequence number: 1403

Authentication Replay – Part 2

IEEE 802.11 wireless LAN management frame

Fixed parameters (6 bytes)

Authentication Algorithm: Open System (0)

Authentication SEQ: 0x0002

Status code: Successful (0x0000)



Association

Association Request – Part 1

```
Frame 12 (41 bytes on wire, 41 bytes captured)
  Arrival Time: Apr  7, 2005 23:30:17.514662000
  Time delta from previous packet: 0.001236000 seconds
  Time since reference or first frame: 0.311735000 seconds
  Frame Number: 12
  Packet Length: 41 bytes
  Capture Length: 41 bytes
  Protocols in frame: wlan
IEEE 802.11
  Type/Subtype: Association Request (0)
  Frame Control: 0x0000 (Normal)
    Version: 0
    Type: Management frame (0)
    Subtype: 0
    Flags: 0x0
      DS status: Not leaving DS or network is operating in AD-HOC mode (To DS: 0
From DS: 0) (0x00)
      .... .0.. = More Fragments: This is the last fragment
      .... 0... = Retry: Frame is not being retransmitted
      ...0 .... = PWR MGT: STA will stay up
      ..0. .... = More Data: No data buffered
      .0.. .... = WEP flag: WEP is disabled
      0... .... = Order flag: Not strictly ordered
  Duration: 258
  Destination address: 00:40:96:5e:0d:64 (AironetW_5e:0d:64)
  Source address: 00:0b:cd:8d:30:3b (172.31.194.10)
  BSS Id: 00:40:96:5e:0d:64 (AironetW_5e:0d:64)
  Fragment number: 0
  Sequence number: 14
```

Association Request – Part 2

IEEE 802.11 wireless LAN management frame

Fixed parameters (4 bytes)

Capability Information: 0x0001

....1 = ESS capabilities: Transmitter is an AP

....0. = IBSS status: Transmitter belongs to a BSS

.... 00.. = CFP participation capabilities: No point coordinator
at AP (0x0000)

....0 = Privacy: AP/STA cannot support WEP

....0. = Short Preamble: Short preamble not allowed

....0.. = PBCC: PBCC modulation not allowed

.... 0... = Channel Agility: Channel agility not in use

.... .0.. = Short Slot Time: Short slot time not in use

..0. = DSSS-OFDM: DSSS-OFDM modulation not allowed

Listen Interval: 0x0001

Tagged parameters (13 bytes)

Tag Number: 0 (SSID parameter set)

Tag length: 5

Tag interpretation: WILMA

Tag Number: 1 (Supported Rates)

Tag length: 4

Tag interpretation: Supported rates: 1.0 2.0 5.5 11.0 [Mbit/sec]

Association Response – Part 1

```
Frame 13 (36 bytes on wire, 36 bytes captured)
  Arrival Time: Apr  7, 2005 23:30:17.517303000
  Time delta from previous packet: 0.002641000 seconds
  Time since reference or first frame: 0.314376000 seconds
  Frame Number: 13
  Packet Length: 36 bytes
  Capture Length: 36 bytes
  Protocols in frame: wlan
IEEE 802.11
  Type/Subtype: Association Response (1)
  Frame Control: 0x0010 (Normal)
    Version: 0
    Type: Management frame (0)
    Subtype: 1
    Flags: 0x0
      DS status: Not leaving DS or network is operating in AD-HOC mode (To DS: 0
From DS: 0) (0x00)
      .... .0.. = More Fragments: This is the last fragment
      .... 0... = Retry: Frame is not being retransmitted
      ...0 .... = PWR MGT: STA will stay up
      ..0. .... = More Data: No data buffered
      .0.. .... = WEP flag: WEP is disabled
      0... .... = Order flag: Not strictly ordered
  Duration: 213
  Destination address: 00:0b:cd:8d:30:3b (172.31.194.10)
  Source address: 00:40:96:5e:0d:64 (AironetW_5e:0d:64)
  BSS Id: 00:40:96:5e:0d:64 (AironetW_5e:0d:64)
  Fragment number: 0
  Sequence number: 1404
```

Association Response – Part 2

IEEE 802.11 wireless LAN management frame

Fixed parameters (6 bytes)

Capability Information: 0x0001

....1 = ESS capabilities: Transmitter is an AP

....0. = IBSS status: Transmitter belongs to a BSS

.... 00.. = CFP participation capabilities: No point coordinator
at AP (0x0000)

....0 = Privacy: AP/STA cannot support WEP

....0. = Short Preamble: Short preamble not allowed

....0.. = PBCC: PBCC modulation not allowed

.... 0... = Channel Agility: Channel agility not in use

.... .0.. = Short Slot Time: Short slot time not in use

..0. = DSSS-OFDM: DSSS-OFDM modulation not allowed

Status code: Successful (0x0000)

Association ID: 0x001d

Tagged parameters (6 bytes)

Tag Number: 1 (Supported Rates)

Tag length: 4

Tag interpretation: Supported rates: 1.0(B) 2.0(B) 5.5(B) 11.0(B) [Mbit/sec]



Data Frames

Data Frame (ARP) – Part 1

```
Frame 693 (78 bytes on wire, 78 bytes captured)
  Arrival Time: May 12, 2004 19:48:17.767774000
  Time delta from previous packet: 0.006368000 seconds
  Time since reference or first frame: 32.158984000 seconds
  Frame Number: 693
  Packet Length: 78 bytes
  Capture Length: 78 bytes
IEEE 802.11
  Type/Subtype: Data (32)
  Frame Control: 0x0208 (Normal)
    Version: 0
    Type: Data frame (2)
    Subtype: 0
    Flags: 0x2
      DS status: Frame is exiting DS (To DS: 0 From DS: 1) (0x02)
      .... .0.. = More Fragments: This is the last fragment
      .... 0... = Retry: Frame is not being retransmitted
      ...0 .... = PWR MGT: STA will stay up
      ..0. .... = More Data: No data buffered
      .0.. .... = WEP flag: WEP is disabled
      0... .... = Order flag: Not strictly ordered
    Duration: 0
  Destination address: ff:ff:ff:ff:ff:ff (Broadcast)
  BSS Id: 00:20:a6:50:da:c1 (Proxim_50:da:c1)
  Source address: 00:00:cd:03:fe:7e (193.205.213.1)
  Fragment number: 0
  Sequence number: 4002
Logical-Link Control
```

Data Frame (ARP) – Part 2

Address Resolution Protocol (request)

Hardware type: Ethernet (0x0001)

Protocol type: IP (0x0800)

Hardware size: 6

Protocol size: 4

Opcode: request (0x0001)

Sender MAC address: 00:00:cd:03:fe:7e (193.205.213.1)

Sender IP address: 193.205.213.1 (193.205.213.1)

Target MAC address: ff:ff:ff:ff:ff:ff (Broadcast)

Target IP address: 193.205.213.177 (193.205.213.177)

Data Frame (Http) – Part 1

```
Frame 1830 (510 bytes on wire, 510 bytes captured)
  Arrival Time: May 12, 2004 19:49:14.356290000
  Time delta from previous packet: 0.001401000 seconds
  Time since reference or first frame: 88.747500000 seconds
  Frame Number: 1830
  Packet Length: 510 bytes
  Capture Length: 510 bytes
IEEE 802.11
  Type/Subtype: Data (32)
  Frame Control: 0x0108 (Normal)
    Version: 0
    Type: Data frame (2)
    Subtype: 0
    Flags: 0x1
      DS status: Frame is entering DS (To DS: 1 From DS: 0) (0x01)
      .... .0.. = More Fragments: This is the last fragment
      .... 0... = Retry: Frame is not being retransmitted
      ...0 .... = PWR MGT: STA will stay up
      ..0. .... = More Data: No data buffered
      .0.. .... = WEP flag: WEP is disabled
      0... .... = Order flag: Not strictly ordered
  Duration: 258
  BSS Id: 00:20:a6:50:da:c1 (Proxim_50:da:c1)
  Source address: 00:0b:cd:8d:30:3b (CompaqHp_8d:30:3b)
  Destination address: 00:00:cd:03:fe:7e (193.205.213.1)
  Fragment number: 0
  Sequence number: 2078
Logical-Link Control
```

Data Frame (Http) – Part 2

```
Internet Protocol, Src Addr: 192.168.213.24 (192.168.213.24), Dst Addr: 193.205.213.166
(193.205.213.166)
Transmission Control Protocol, Src Port: 3346 (3346), Dst Port: 3128 (3128), Seq: 1,
Ack: 1, Len: 438
Hypertext Transfer Protocol
GET http://www.google.it/ HTTP/1.0\r\n
    Request Method: GET
    Accept: image/gif, image/x-xbitmap, image/jpeg, image/pjpeg, application/vnd.ms-
excel, application/vnd.ms-powerpoint, application/msword, application/x-shockwave-
flash, */*\r\n
    Accept-Language: en-gb\r\n
    Cookie:
    PREF=ID=3e55d6d171be104c:LD=it:TM=1070627809:LM=1070627809:S=PTw_56YWtiEG1MLL\r\n
    User-Agent: Mozilla/4.0 (compatible; MSIE 6.0; Windows NT 5.1)\r\n
    Host: www.google.it\r\n
    Proxy-Connection: Keep-Alive\r\n
\r\n
```





Acknowledgment

Control Frame: ACK

- ❑ All the unicast traffic frames must receive an ACK frame
- ❑ A *data frame* will use NAV to reserve the channel for the *data frame*, his ACK and SIFS (Short Inter Frame Space)
- ❑ With this NAV, the sender ensures to the receiver of the data frame the possibility of sending ACK

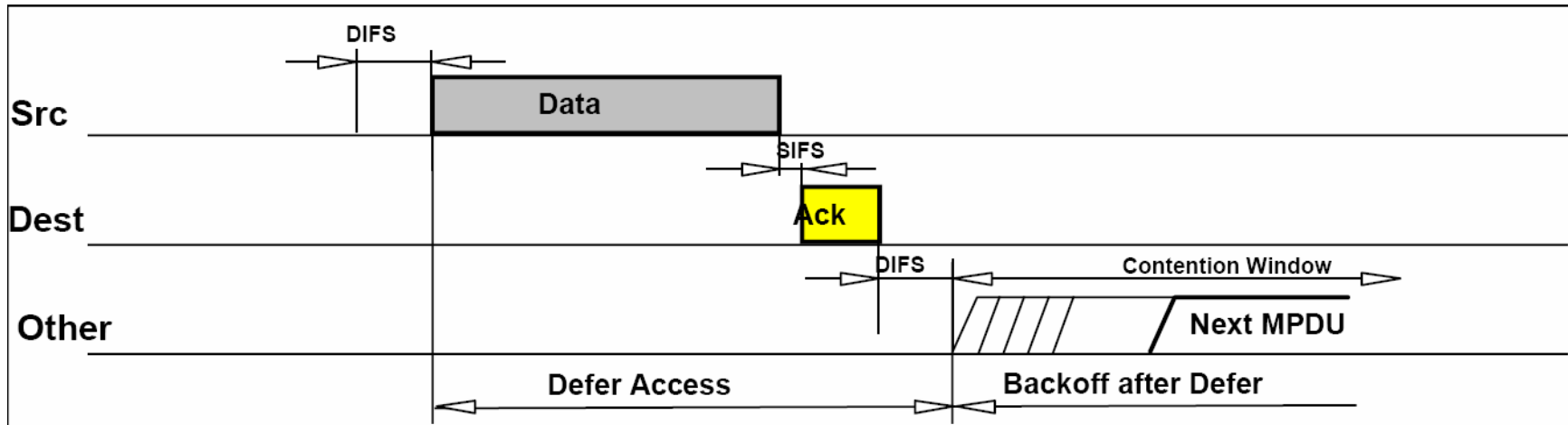
Control Frame: ACK



Data Frame: HTTP – Part 1

```
Frame 1 (286 bytes on wire, 286 bytes captured)
  Arrival Time: Apr  8, 2005 10:04:58.768578000
  Time delta from previous packet: 0.000000000 seconds
  Time since reference or first frame: 0.000000000 seconds
  Frame Number: 1
  Packet Length: 286 bytes
  Capture Length: 286 bytes
  Protocols in frame: wlan:llc:ip:tcp:http
IEEE 802.11
  Type/Subtype: Data (32)
  Frame Control: 0x0108 (Normal)
    Version: 0
    Type: Data frame (2)
    Subtype: 0
    Flags: 0x1
      DS status: Frame is entering DS (To DS: 1 From DS: 0) (0x01)
      .... .0.. = More Fragments: This is the last fragment
      .... 0... = Retry: Frame is not being retransmitted
      ...0 .... = PWR MGT: STA will stay up
      ..0. .... = More Data: No data buffered
      .0.. .... = WEP flag: WEP is disabled
      0... .... = Order flag: Not strictly ordered
  Duration: 213
  BSS Id: 00:20:a6:50:da:ca (Proxim_50:da:ca)
  Source address: 00:0b:cd:8d:30:3b (CompaqHp_8d:30:3b)
  Destination address: 00:0b:db:73:2b:16 (DellEsgP_73:2b:16)
```

Data Frame: HTTP – Part 2

Fragment number: 0

Sequence number: 2505

Logical-Link Control

Internet Protocol, Src Addr: 172.31.194.10 (172.31.194.10), Dst Addr: 193.205.213.166 (193.205.213.166)

Transmission Control Protocol, Src Port: 3072 (3072), Dst Port: 3128 (3128), Seq: 0, Ack: 0, Len: 214

Source port: 3072 (3072)

Destination port: 3128 (3128)

Sequence number: 0 (relative sequence number)

Next sequence number: 214 (relative sequence number)

Acknowledgement number: 0 (relative ack number)

Header length: 20 bytes

Flags: 0x0018 (PSH, ACK)

Window size: 17047

Checksum: 0xf08e (correct)

Hypertext Transfer Protocol

GET http://www.unitn.it/scienze/ HTTP/1.0\r\n

Accept: */*\r\n

Accept-Language: en-gb\r\n

Pragma: no-cache\r\n

User-Agent: Mozilla/4.0 (compatible; MSIE 6.0; Windows NT 5.1)\r\n

Host: www.unitn.it\r\n

Proxy-Connection: Keep-Alive\r\n

\r\n

ACK Frame

Frame 2 (10 bytes on wire, 10 bytes captured)

Arrival Time: Apr 8, 2005 10:04:58.768639000

Time delta from previous packet: 0.000061000 seconds

Time since reference or first frame: 0.000061000 seconds

Frame Number: 2

Packet Length: 10 bytes

Capture Length: 10 bytes

Protocols in frame: wlan

IEEE 802.11

Type/Subtype: [Acknowledgement \(29\)](#)

Frame Control: 0x00D4 (Normal)

Version: 0

Type: Control frame (1)

Subtype: 13

Flags: 0x0

DS status: Not leaving DS or network is operating in AD-HOC mode (To DS: 0
From DS: 0) (0x00)

.... .0.. = More Fragments: This is the last fragment

.... 0... = Retry: Frame is not being retransmitted

...0 = PWR MGT: STA will stay up

..0. = More Data: No data buffered

.0.. = WEP flag: WEP is disabled

0... = Order flag: Not strictly ordered

Duration: 0

Receiver address: [00:0b:cd:8d:30:3b](#) (CompaqHp_8d:30:3b)



Configuration of CISCO AP 1200 Series

AP 1200: Features

□ This AP supports:

- Multiple SSID (up to 16). For each one it is possible to choose:
 - If transmitting in broadcast the SSID (guests mode)
 - The method of authentication
 - The maximum number of customers
 - VLAN: a VLAN for each SSID
- Authentication Methods:
 - MAC Address
 - 802.1x
 - WPA

AP 1200: Initial Configuration

- Configuration using serial port
 - 9600 baud
 - 8 data bits
 - Parity none
 - stop bit 1
 - flow control no

AP 1200: Initial Configuration

□ “Standard” CISCO commands:

- enable
- *Password* → Cisco
- `configure [terminal]`
- `ip default-gateway 192.168.10.1`
- `interface BVI 1`
- `ip address 192.168.10.40 255.255.255.0`
- exit
- Ctrl-z
- `copy running-config startup-config`
- reload

AP 1200: Initial Configuration

- To display the initial configuration:
 - Enable
 - Password: Cisco
 - `show running-config`

AP 1200: WEB Interface

- After the first configuration via CLI:

HOME
EXPRESS SET-UP
EXPRESS SECURITY
NETWORK MAP +
ASSOCIATION +
NETWORK INTERFACES +
SECURITY +
SERVICES +
WIRELESS SERVICES +
SYSTEM SOFTWARE +
EVENT LOG +

Hostname CISCO1200-NetworkLab

Express Set-Up

Host Name:	<input type="text" value="CISCO1200-NetworkLab"/>
MAC Address:	<input type="text" value="000d.2967.cef5"/>
Configuration Server Protocol:	<input type="radio"/> DHCP <input checked="" type="radio"/> Static IP
IP Address:	<input type="text" value="192.168.10.40"/>
IP Subnet Mask:	<input type="text" value="255.255.255.0"/>
Default Gateway:	<input type="text" value="192.168.10.1"/>
SNMP Community:	<input type="text" value="defaultCommunity"/>
	<input checked="" type="radio"/> Read-Only <input type="radio"/> Read-Write

Radio0-802.11B

Role in Radio Network:	<input checked="" type="radio"/> Access Point Root <input type="radio"/> Repeater Non-Root
Optimize Radio Network for:	<input checked="" type="radio"/> Throughput <input type="radio"/> Range <input type="radio"/> Custom
Aironet Extensions:	<input checked="" type="radio"/> Enable <input type="radio"/> Disable

AP 1200: Firmware Update

- The Firmware is downloadable from the CISCO WEB Site:
 - <http://tools.cisco.com/support/downloads/go/Redirect.x?mdfid=278875243>
 - You have to register at least as guest user
 - The current version is: c1200-k9w7-tar.123-8.JEE.tar (but it's not available for guest users)
 - The AP firmware can be updated via tftp or via http

AP 1200: Wireless Configuration

- Role in a Wireless Network:
 - Root/Repeater
- Power:
 - You can limit the power of the AP radio
 - It is also possible to limit the power (in transmission) of the client stations (CISCO extensions)

AP 1200: Wireless Configuration

□ Speed:

- Basic (Require in WEB Interface): unicast and multicast traffic, used from the highest to the lowest. At least one rate must be set to basic. Note that if the client doesn't support a Basic rate, it can not associate to the AP
- Enabled: Unicast traffic only
- Disabled: This speed is not usable

AP 1200: Wireless Configuration

□ Configuration of the basic parameters

The screenshot shows the configuration page for the Radio0-802.11B interface. The page is divided into several sections: RADIO0-802.11B STATUS, DETAILED STATUS, SETTINGS, and CARRIER BUSY TEST. The current page is the SETTINGS section.

Hostname: CISCO1200-NetworkLab
CISCO1200-NetworkLab uptime is 3

Network Interfaces: Radio0-802.11B Settings

Enable Radio: Enable Disable

Current Status (Software/Hardware): Enabled ↑ Up ↑

Role in Radio Network: (Fallback mode upon loss of Ethernet connection)

- Access Point Root (Fallback to Radio Island)
- Access Point Root (Fallback to Radio Shutdown)
- Access Point Root (Fallback to Repeater)
- Repeater Non-Root

Data Rates: Best Range Best Throughput

1.0Mb/sec	<input checked="" type="radio"/> Require	<input type="radio"/> Enable	<input type="radio"/> Disable
2.0Mb/sec	<input checked="" type="radio"/> Require	<input type="radio"/> Enable	<input type="radio"/> Disable
5.5Mb/sec	<input checked="" type="radio"/> Require	<input type="radio"/> Enable	<input type="radio"/> Disable
11.0Mb/sec	<input checked="" type="radio"/> Require	<input type="radio"/> Enable	<input type="radio"/> Disable

Transmitter Power (mW): 1 5 20 30 50 Max

Limit Client Power (mW): 1 5 20 30 50 Max

Default Radio Channel: Least Congested Frequency Channel 10 2457 MHz

Least Congested Channel Search: (Use Only Selected Channels)

- Channel 1 - 2412 MHz
- Channel 2 - 2417 MHz
- Channel 3 - 2422 MHz
- Channel 4 - 2427 MHz
- Channel 5 - 2432 MHz
- Channel 6 - 2437 MHz
- Channel 7 - 2442 MHz
- Channel 8 - 2447 MHz
- Channel 9 - 2452 MHz
- Channel 10 - 2457 MHz

AP 1200: Wireless Configuration

□ World Mode:

- Clients can receive “national” information about setting. Legacy for CISCO compatibility, 802.11d new standards

□ Antenna:

- Diversity: both antennas are used and the one that receives the best signal is chosen

□ Encapsulation:

- To manage the non 802.3 packages, these have to be encapsulated. Interoperability with others: RFC1042; 802.1H optimized for CISCO

AP 1200: Wireless Configuration

□ RTS:

- Choose low values if not all of the stations are within sensing range of each other

□ Fragmentation:

- Choose low values if the area is disturbed or with low transmission quality

□ CISCO Extension:

- Used to support special features

AP 1200: Wireless Configuration

□ Configuration of the basic parameters

World Mode	<input type="radio"/> Disable	<input type="radio"/> Legacy	<input checked="" type="radio"/> Dot11d
Multi-Domain Operation:			
Country Code:	Italy <input type="text"/>	<input checked="" type="checkbox"/> Indoor	<input checked="" type="checkbox"/> Outdoor
Radio Preamble	<input checked="" type="radio"/> Short	<input type="radio"/> Long	
Receive Antenna:	<input checked="" type="radio"/> Diversity	<input type="radio"/> Left (Secondary)	<input type="radio"/> Right (Primary)
Transmit Antenna:	<input checked="" type="radio"/> Diversity	<input type="radio"/> Left (Secondary)	<input type="radio"/> Right (Primary)
External Antenna Configuration:	<input type="radio"/> Enable	<input checked="" type="radio"/> Disable	
	Antenna Gain(dB): DISABLED (-128 - 128)		
Aironet Extensions:	<input checked="" type="radio"/> Enable	<input type="radio"/> Disable	
Ethernet Encapsulation Transform:	<input checked="" type="radio"/> RFC1042	<input type="radio"/> 802.1H	
Reliable Multicast to WGB:	<input checked="" type="radio"/> Disable	<input type="radio"/> Enable	
Public Secure Packet Forwarding:	<input type="radio"/> Enable	<input checked="" type="radio"/> Disable	
Beacon Period:	<input type="text" value="100"/> (20-4000 Kusec)	Data Beacon Rate (DTIM):	<input type="text" value="2"/> (1-100)
Max. Data Retries:	<input type="text" value="64"/> (1-128)	RTS Max. Retries:	<input type="text" value="64"/> (1-128)
Fragmentation Threshold:	<input type="text" value="2346"/> (256-2346)	RTS Threshold:	<input type="text" value="2312"/> (0-2347)
Repeater Parent AP Timeout:	<input type="text" value="0"/> (0-65535 sec)		
Repeater Parent AP MAC 1 (optional):	<input type="text"/> (HHHH.HHHH.HHHH)		
Repeater Parent AP MAC 2 (optional):	<input type="text"/> (HHHH.HHHH.HHHH)		
Repeater Parent AP MAC 3 (optional):	<input type="text"/> (HHHH.HHHH.HHHH)		
Repeater Parent AP MAC 4 (optional):	<input type="text"/> (HHHH.HHHH.HHHH)		

AP 1200: Wireless Configuration

□ Channel Selection:

- It is possible to make the AP choose the channel automatically
- It is possible to set it manually
- It is possible to do a survey to determine the state of the channels in the area

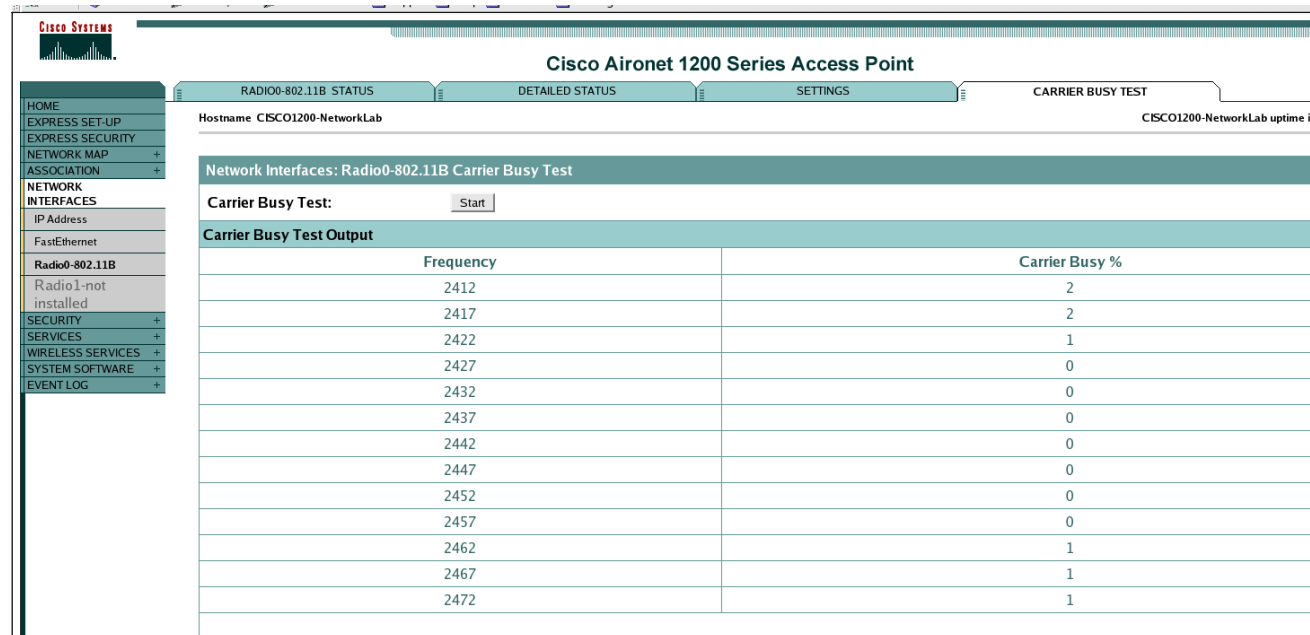

The screenshot displays the configuration page for a Cisco Aironet 1200 Series Access Point. The page title is "Cisco Aironet 1200 Series Access Point". The navigation menu on the left includes: HOME, EXPRESS SET-UP, EXPRESS SECURITY, NETWORK MAP, ASSOCIATION, NETWORK INTERFACES, IP Address, FastEthernet, Radio0-802.11B, SECURITY, SERVICES, WIRELESS SERVICES, SYSTEM SOFTWARE, and EVENT LOG. The main content area shows the "Radio0-802.11B" configuration page, with tabs for "RADIO0-802.11B STATUS", "DETAILED STATUS", "SETTINGS", and "CARRIER BUSY TEST". The "CARRIER BUSY TEST" tab is active, showing a "Carrier Busy Test" section with a "Start" button. Below this is a "Carrier Busy Test Output" table with the following data:

Frequency	Carrier Busy %
2412	2
2417	2
2422	1
2427	0
2432	0
2437	0
2442	0
2447	0
2452	0
2457	0
2462	1
2467	1
2472	1

AP 1200: SSID and Authentication

□ SSID:

- You have to define an SSID. Default "tsunami"
- Guest SSID: is the SSID advertised

□ Authentications:

- Open: all the devices are allowed to authenticate with the AP
- Shared: there is an exchange of a message plain or encrypted. Unsafe
- EAP: the safest mode

□ Authentication based on MAC:

- Open authentication → "With MAC Authentication"

AP 1200: SSID and Authentication

□ Definition of Cryptography

The screenshot shows the configuration page for the Security: Encryption Manager on a Cisco Aironet 1200 Series Access Point. The page is titled "Cisco Aironet 1200 Series Access Point" and shows the hostname "CISCO1200-NetworkLab" and uptime "2 days, 49 minutes".

Security: Encryption Manager

Set Encryption Mode and Keys for VLAN: 3 [Define VLANs](#)

Encryption Modes

- None
- WEP Encryption Cisco Compliant TKIP Features: Enable Message Integrity Check (MIC) Enable Per Packet Keying (PPK)
- Cipher

Encryption Keys

	Transmit Key	Encryption Key (Hexadecimal)	Key Size
Encryption Key 1:	<input checked="" type="radio"/>	<input type="text" value="*****"/>	128 bit
Encryption Key 2:	<input type="radio"/>	<input type="text"/>	128 bit
Encryption Key 3:	<input type="radio"/>	<input type="text"/>	128 bit
Encryption Key 4:	<input type="radio"/>	<input type="text"/>	128 bit

Global Properties

Broadcast Key Rotation Interval: Disable Rotation Enable Rotation with Interval: (10-10000000 sec)

WPA Group Key Update: Enable Group Key Update On Membership Termination Enable Group Key Update On Member's Capability Change

AP 1200: Configuration via CLI

□ All the configurations via HTTP are possible via CLI

■ show running-config

```
interface Dot11Radio0
  no ip address
  no ip route-cache
  !
  encryption vlan 3 key 1 size 128bit 7 501B2057424875554B78965D207B
  transmit-key
  encryption vlan 3 mode wep mandatory
  !
  ssid CREATE-NET-TEST
    vlan 4
    authentication open mac-address mac_methods
    accounting acct_methods
    mobility network-id 4
    information-element ssid advertisement
  !
  ssid WILMA-LAB
    vlan 3
    authentication open mac-address mac_methods
    accounting acct_methods
    mobility network-id 3
    information-element ssid advertisement
  !
  ssid WILMA-LAB-TEST
    vlan 5
    authentication open mac-address mac_methods
    accounting acct_methods
    guest-mode
    mobility network-id 5
```



Configuration of LinkSys AP WAP54G

WAP54G: Firmware Update

- The Firmware is downloadable from the LinkSys WEB Site:
 - <http://www.linksysbycisco.com/US/en/support/WAP54G>
 - The AP firmware can be updated via http

WAP54G: WEB Interface

- We can configure it via WEB interface:

The screenshot displays the Linksys WAP54G web interface. At the top, the Linksys logo and "A Division of Cisco Systems, Inc." are on the left, and "Firmware Version: 3.04" is on the right. Below this, a navigation bar shows "Wireless-G Access Point" and "WAP54G". A "Setup" sidebar is on the left, with "Network Setup" selected. The main content area is titled "Network Setup" and contains the following fields:

- Device Name:** Linksys WAP54G
- Configuration Type:** Static IP
- IP Address:** 192 . 168 . 10 . 15
- Subnet Mask:** 255 . 255 . 255 . 0
- Default Gateway:** 192 . 168 . 10 . 1

At the bottom, there are "Save Settings" and "Cancel Changes" buttons. A "Help..." link is visible on the right side of the interface. The Cisco Systems logo is in the bottom right corner.

WAP54G: WEB Interface

- From the main page you can change the B/G/mixed mode:

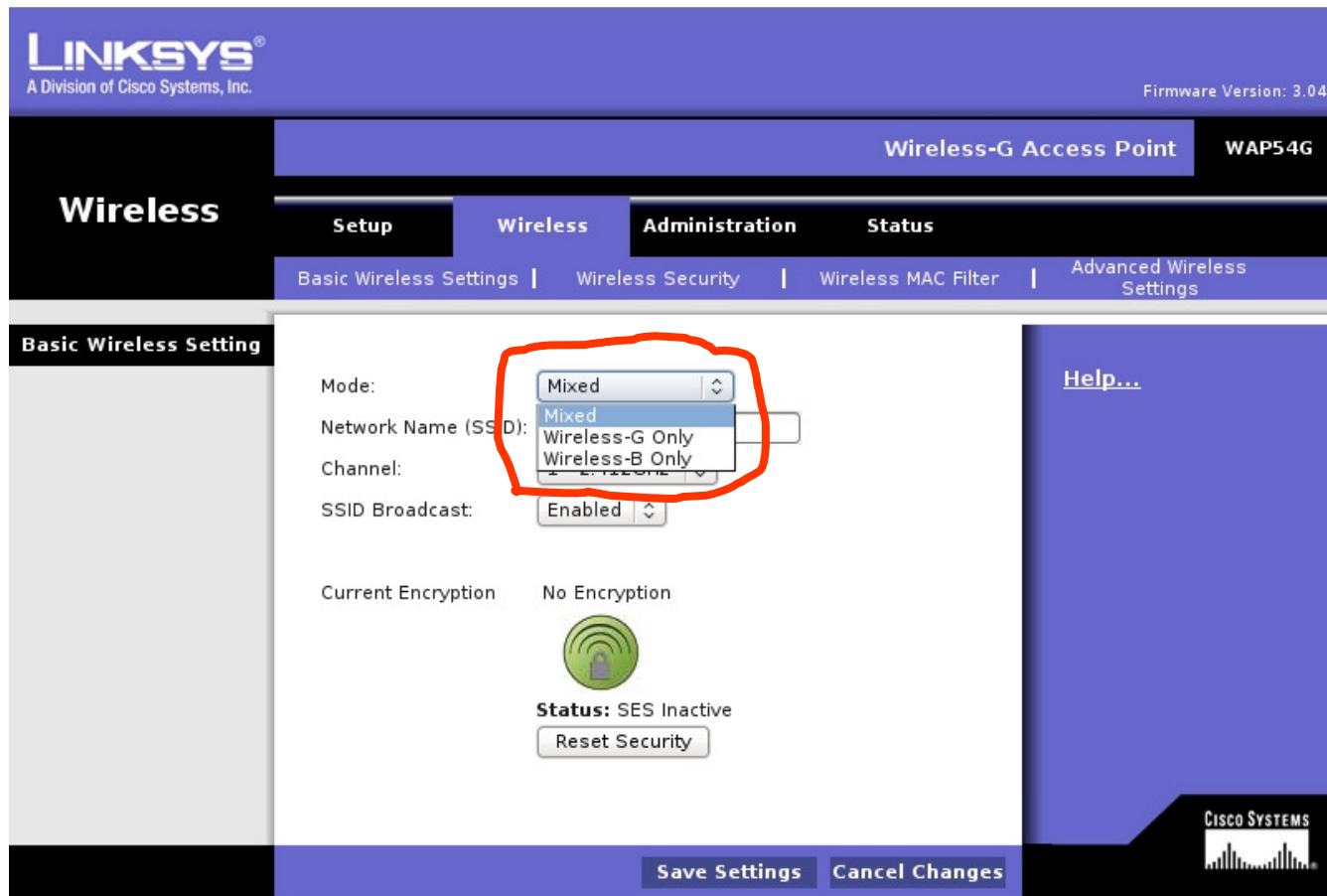

The screenshot displays the Linksys WAP54G web interface. The top navigation bar includes the Linksys logo, "A Division of Cisco Systems, Inc.", and "Firmware Version: 3.04". The main navigation area shows "Wireless" as the active section, with sub-tabs for "Setup", "Wireless", "Administration", and "Status". The "Wireless" sub-tab is further divided into "Basic Wireless Settings", "Wireless Security", "Wireless MAC Filter", and "Advanced Wireless Settings". The "Basic Wireless Setting" page is shown, with the "Mode" dropdown menu highlighted by a red circle. The dropdown menu lists three options: "Mixed", "Wireless-G Only", and "Wireless-B Only". Other settings visible include "Network Name (SSID)", "Channel", "SSID Broadcast" (set to "Enabled"), "Current Encryption" (set to "No Encryption"), and a "Status: SES Inactive" indicator with a "Reset Security" button. The bottom of the page features "Save Settings" and "Cancel Changes" buttons, along with the Cisco Systems logo.

WAP54G: WEB Interface

- In the Advanced page, Advanced Wireless tab, you can modify a lot of parameters:

The screenshot displays the Linksys WAP54G web interface. At the top, the Linksys logo and "A Division of Cisco Systems, Inc." are on the left, and "Firmware Version: 3.04" is on the right. Below this is a navigation bar with "Wireless-G Access Point" and "WAP54G". The main navigation menu includes "Wireless", "Setup", "Wireless", "Administration", and "Status". Under "Wireless", there are sub-tabs: "Basic Wireless Settings", "Wireless Security", "Wireless MAC Filter", and "Advanced Wireless Settings". The "Advanced Wireless" section is active, showing various configuration options:

- Authentication Type: Open System(Default) ▾
- Basic Rates: Default ▾
- Transmission Rates: Auto(Default) ▾
- CTS Protection Mode: Disable ▾
- Frame Burst Mode: Disabled ▾
- Antenna Selection: Diversity ▾
- Beacon Interval: 100 (Default: 100, Milliseconds, Range: 20~1000)
- DTIM Interval: 3 (Default: 3, Range: 1 - 255)
- Fragmentation Threshold: 2346 (Default: 2346, Range: 256 - 2346)
- RTS Threshold: 2346 (Default: 2346, Range: 256 - 2346)

At the bottom, there are "Save Settings" and "Cancel Changes" buttons. A "Help..." link is visible on the right side. The Cisco Systems logo is in the bottom right corner.

WAP54G: WEB Interface

- For this AP you can change:
 - The Fragmentation Threshold
 - The Transmitting speed
 - The RTS Threshold
 - The mode (B/G/Mixed)



Configurations of our Testbed

Setup of the Lab: AP Cisco

- Cisco 1310:
 - IP: 192.168.10.5
 - SSID: NCG
 - Login: empty
 - Passwd: `Cisco`
 - Channel: 7
- Cisco 1230B:
 - IP: 192.168.10.10
 - SSID: NCB
 - Login: empty
 - Passwd: `Cisco`
 - Channel: 13

Setup of the Lab : LinkSys

- LinkSys WAP54G:
 - IP: 192.168.10.15
 - SSID: NCL
 - Login: empty
 - Password: `admin`
 - Channel: 1

Setup of the Lab : setup

- ❑ Server: 192.168.10.30
- ❑ Login: `root`
- ❑ Passwd: `students`
- ❑ Connect all the device (the 3 AP and the laptop-server) to the switch
- ❑ Startup of services:
 - `/etc/init.d/networking restart`
 - `/etc/init.d/dhcp3-server restart`



Tools for the analysis of the performances of a network

Network Performance

- Several tools exist for the performances measurement of a network each one with different purposes:
 - Iperf:
 - <http://iperf.sourceforge.net/>
 - d-itg:
 - <http://www.grid.unina.it/software/ITG/>
 - Netperf:
 - <http://www.netperf.org/netperf/NetperfPage.html>
 - Rude&crude
 - <http://rude.sourceforge.net/>



D-ITG

D-ITG

- D-ITG (Distributed Internet Traffic Generator) is downloadable from:
 - <http://www.grid.unina.it/software/ITG/>
- The last stable version V:2.6.1d
- The manual is available at the address:
 - <http://www.grid.unina.it/software/ITG/codice/D-ITG2.6.1d-manual.pdf>

D-ITG

- D-ITG is composed by a number of different tools. The most important three are:
 - ITGSend: the sender
 - ITGRecv: the receiver
 - ITGDec: the log decoder

D-ITG

- ❑ To run D-ITG, we have to start the tool on the server side in receiving mode:
 - `user@server:~> ITGRecv`
- ❑ The default port is 8999
- ❑ Optionally you can specify the protocol (UDP or TCP). The default is UDP

D-ITG

- ❑ ITGSend is the tool to use to generate the flows of traffic
- ❑ It has a lot of options:
 - We can generate the packets with different payload
 - We can generate the packets with different inter-departure time
 - We can generate packets using different protocols (TCP, UDP, DNS, Telnet, VoIP, ...)

D-ITG

□ A basic example is the following:

- `user@server:~> ITGSend -a 192.168.10.30 -C 200 -c 1400 -t 30000 -x remote.log -l local.log`

■ In this example:

- Connect with the server 192.168.10.30 (-a flag)
- The packets are generate at a constant rate of 200 Packets per Second (-C)
- The Packet have 1400 byte constant payload (-c)
- Generate 30 Seconds of traffic (-t)
- Save the log locally in the file local.log (-l) and on the remote server in the file remote.log (-x)

D-ITG

- ❑ ITGDec is the utility to decode and analyze the log
- ❑ N.B.: to obtain coherent results, the clock of the sender and of the receiver must be synchronized (NTP is the simpler solution)

D-ITG

□ In our simple case we have:

■ `user@server:~> ITGDec remote.log`

□ The result is something like:

```
\-----  
Flow number: 1  
From 192.168.10.110:32769  
To   192.168.10.30:8999  
-----  
Total time           =      19.998916 s  
Total packets        =           3830  
Minimum delay        =      0.027108 s  
Maximum delay        =      0.088890 s  
Average delay        =      0.030711 s  
Average jitter       =      0.001759 s  
Delay standard deviation =      0.007118 s  
Bytes received       =      5362000  
Average bitrate      =    2144.916254 Kbit/s  
Average packet rate  =      191.510380 pkt/s  
Packets dropped      =           110 (2.79 %)  
-----
```



Netperf

Netperf

- ❑ Netperf is a benchmark tool, useful to measure the network performance
- ❑ The software is available at the address:
 - <ftp://ftp.netperf.org/netperf/>
- ❑ The main site for netperf is:
 - <http://www.netperf.org/netperf/>
- ❑ There is also a complete manual of the tools (HTML and pdf):
 - <http://www.netperf.org/netperf/training/Netperf.html>
 - <http://www.netperf.org/svn/netperf2/tags/netperf-2.4.5/doc/netperf.pdf>

Netperf

- ❑ To run netperf, we have to start the netserv tool on the server side :
 - `user@server:~> netserver`
- ❑ The default port is 12865
- ❑ You don't have to specify the protocol

Netperf

- ❑ netperf is the tool to use to measure the performance of the network
- ❑ It has a many different options:
 - We can measure the performance of the network evaluating different type of traffic
 - The two most interesting type of traffics for our intent are
 - ❑ TCP stream (the default)
 - ❑ UDP stream

Netperf

□ A basic example is the following:

- `user@server:~> netperf -l 20 -H 192.168.10.30 -t UDP_STREAM -fb`

■ In this example:

- The test will last for 20 Seconds (-l)
- Connect with the server 192.168.10.30 (-H)
- The type of traffic to evaluate is UDP (-t)
- The output format is in KByte/sec (-f)

Netperf

- In our simple example the result we obtain is something like:

```
UDP UNIDIRECTIONAL SEND TEST from 0.0.0.0 (0.0.0.0) port 0 AF_INET
  to 192.168.10.30 (192.168.10.30) port 0 AF_INET : demo
```

Socket Size bytes	Message Size bytes	Elapsed Time secs	Messages		Throughput
			Okay #	Errors #	KBytes/sec
114688	65507	20.00	245	0	783.64
111616		20.00	243		777.25

- The interesting line is the last, where we have the performance from the point of view of the receiver with a measured throughput of 777.25 KB/sec



Iperf

Iperf

- Iperf has a many options:
- Issue the command `iperf -- help` for the full list
- The most interesting one:
 - `-u`: use UDP instead of TCP (SUGGESTED)
 - `-s`: run iperf in server mode
 - `-c`: run iperf in client mode
 - `-b`: the offered load in bit/sec
 - `-d`: run a bidirectional test simultaneously
 - `-r`: run a bidirectional test individually

Iperf

- ❑ To run IPERF as server (IP Address 192.168.10.30) :

- `iperf -u -s`

- ❑ To run IPERF as a client:

- `iperf -c 192.168.10.30 -u -b20M -i 5 -t 40`

- Where:

- ❑ -i 5 means a report any 5 seconds
 - ❑ -t 40 means a simulation 40 seconds long
 - ❑ -u means UDP transfer mode
 - ❑ -b 20M means 20Mbit/sec offered load (bandwidth for iperf)

Iperf

- Iperf has a CSV output. The option is `-yc`
- You can find a nice description of Iperf and his parameters at the following URL:
 - <http://openmaniak.com/iperf.php>



Ad Hoc Networks

Ad Hoc Networks (IBSS)

- ❑ The wireless LANs we usually know use the “infrastructured” mode which requires one or more Access Points
- ❑ The 802.11 standard specifies an additional mode:
 - Ad hoc mode**
- ❑ This mode let the 802.11 network card operate in what the standard defines a network configuration “Independent Basic Service Set (IBSS)”
- ❑ In IBSS mode there are no Access Points and the various network cards communicate directly among them in peer-to-peer mode

Ad Hoc Networks (IBSS)

- The Ad Hoc mode allows the users to constitute a wireless LAN autonomously
- Typical applications:
 - Files and resources sharing among laptops
 - Application of first aid in emergency situations (disasters, accidents, fires, ...)

Ad Hoc Networks (IBSS)

□ Advantages/disadvantages:

- **Reduced costs:** no AP, no cost of infrastructuration
- **Reduced setup time:** It is enough that users have the wireless network cards
- **Performance:** In a communication among two clients is better the Ad Hoc mode, otherwise ... it depends
- **Reduced access to the net:** Generally there is no access to the wired net, in some cases a single client can share its connection to the others clients, however it is not a good solution!
- **Management of a complex network:** given the fluidity of the network topology and the lack of a centralized device, the security management and the performance analysis is extremely complex

Ad Hoc Networks (IBSS)

- The first station for a particular Ad Hoc network (that is, the first NIC radio) establishes the IBSS determining the BSSID address:
 - In a infrastructured network the BSSID is the address of the wireless interface of the AP
 - In an Ad Hoc network, the BSSID is generated in a random way

Ad Hoc Networks (IBSS)

- A BSSID is reserved, the broadcast BSSID (all the bits to 1):
 - Frames with broadcast BSSID jump all the BSSID filters on the MAC level
 - This address is only used when stations try to identify a net sending a probe request
 - Only the probe request frames can use the BSSID broadcast

Ad Hoc Networks (IBSS)

- Afterwards the first station starts sending beacons, needed to keep the synchronization among the stations
- Note that in infrastructure mode, only the Access Point can send beacons

Ad Hoc Networks (IBSS)

- ❑ The other stations of the Ad Hoc network will join to the net after receiving a beacon and accepting the parameters of IBSS (in particular the interval of beacon) sent in the beacon frame
- ❑ All the stations which join the Ad Hoc network must periodically send a beacon if they do not hear a beacon from another station after a very short random delay from when they presume that beacon had to be sent



Ad-Hoc Network Setup

Ad Hoc Network: Setup

- ❑ Start the laptop in linux
- ❑ Login with user utente and password utente
- ❑ Setup the configuration of the AdHoc Network:
 - `sudo /sbin/iwconfig eth0 mode ad-hoc essid AHXX channel y rate xM`
(with $x = 1, 2, 5.5, 6, \dots, 54$)
 - `sudo /sbin/ifconfig eth0 10.10.10.zz`
with all the clients in the same Ad Hoc Network use different IP (different zz numbers)

Ad Hoc Network: Setup

- To verify the setup:

```
sudo /sbin/iwconfig eth0
```

You will obtain something like:

```
IEEE 802.11g  ESSID:"TEST"  
Mode:Ad-Hoc  Frequency:2.432 GHz  Cell: 02:15:00:E2:6F:3E  
Bit Rate:54 Mb/s  Tx-Power=20 dBm  Sensitivity=8/0  
Retry limit:7  RTS thr:off  Fragment thr:off  
Encryption key:off  
Power Management:off  
Link Quality=67/100  Signal level=-60 dBm  Noise level=-85 dBm  
Rx invalid nwid:0  Rx invalid crypt:0  Rx invalid frag:0  
Tx excessive retries:0  Invalid misc:40  Missed beacon:0
```

Ad Hoc Network: Setup

- ❑ Start netperf in server mode on one of the laptops:

```
user@ad-hoc-1:~> netserv
```

- ❑ Run netperf in client mode on the other laptops.
For instance:

```
user@ad-hoc-2:~> netperf -l 20 -H xxx.yyy.zzz.www -t  
UDP_STREAM -fb
```



Analysis of Ad Hoc Network packets

Probe Request

- Initially empty frame of *Probe Request* with BSSID FF:FF:FF:FF:FF:FF and with SSID either empty or with default SSID or the SSID of the Ad Hoc network

Probe Request (with ID) – Part 1

Frame 3 (51 bytes on wire, 51 bytes captured)

IEEE 802.11

Type/Subtype: Probe Request (4)

Frame Control: 0x0040 (Normal)

Version: 0

Type: Management frame (0)

Subtype: 4

Flags: 0x0

DS status: Not leaving DS or network is operating in AD-HOC mode (To DS: 0
From DS: 0) (0x00)

.... .0.. = More Fragments: This is the last fragment

.... 0... = Retry: Frame is not being retransmitted

...0 = PWR MGT: STA will stay up

..0. = More Data: No data buffered

.0.. = WEP flag: WEP is disabled

0... = Order flag: Not strictly ordered

Duration: 0

Destination address: ff:ff:ff:ff:ff:ff (Broadcast)

Source address: 00:0e:35:6e:20:39 (10.0.0.11)

BSS Id: ff:ff:ff:ff:ff:ff (Broadcast)

Fragment number: 0

Sequence number: 1

Probe Request (with ID) – Part 2

IEEE 802.11 wireless LAN management frame

Tagged parameters (27 bytes)

Tag Number: 0 (SSID parameter set)

Tag length: 9

Tag interpretation: **WNLABTEST**

Tag Number: 1 (Supported Rates)

Tag length: 4

Tag interpretation: Supported rates: 1.0(B) 2.0(B) 5.5 11.0 [Mbit/sec]

Tag Number: 50 (Extended Supported Rates)

Tag length: 8

Tag interpretation: Supported rates: 6.0 9.0 12.0 18.0 24.0 36.0 48.0 54.0
[Mbit/sec]

Probe Request (without ID) – Part 1

Frame 4 (42 bytes on wire, 42 bytes captured)

IEEE 802.11

Type/Subtype: Probe Request (4)

Frame Control: 0x0040 (Normal)

Version: 0

Type: Management frame (0)

Subtype: 4

Flags: 0x0

DS status: Not leaving DS or network is operating in AD-HOC mode (To DS: 0
From DS: 0) (0x00)

.... .0.. = More Fragments: This is the last fragment

.... 0... = Retry: Frame is not being retransmitted

...0 = PWR MGT: STA will stay up

..0. = More Data: No data buffered

.0.. = WEP flag: WEP is disabled

0... = Order flag: Not strictly ordered

Duration: 0

Destination address: ff:ff:ff:ff:ff:ff (Broadcast)

Source address: 00:0e:35:6e:20:39 (10.0.0.11)

BSS Id: ff:ff:ff:ff:ff:ff (Broadcast)

Fragment number: 0

Sequence number: 2

Probe Request (without ID) – Part 2

IEEE 802.11 wireless LAN management frame

Tagged parameters (18 bytes)

Tag Number: 0 (SSID parameter set)

Tag length: 0

Tag interpretation:

Tag Number: 1 (Supported Rates)

Tag length: 4

Tag interpretation: Supported rates: 1.0(B) 2.0(B) 5.5 11.0 [Mbit/sec]

Tag Number: 50 (Extended Supported Rates)

Tag length: 8

Tag interpretation: Supported rates: 6.0 9.0 12.0 18.0 24.0 36.0 48.0 54.0
[Mbit/sec]

Beacon Frame

- ❑ Waited for a certain time interval the *Beacon Frame* starts
- ❑ In the beacon now there is the BSSID chosen in random way

Beacon Frame – Part 1

Frame 32 (82 bytes on wire, 82 bytes captured)

IEEE 802.11

Type/Subtype: Beacon frame (8)

Frame Control: 0x0080 (Normal)

Version: 0

Type: Management frame (0)

Subtype: 8

Flags: 0x0

DS status: Not leaving DS or network is operating in AD-HOC mode (To DS: 0
From DS: 0) (0x00)

.... .0.. = More Fragments: This is the last fragment

.... 0... = Retry: Frame is not being retransmitted

...0 = PWR MGT: STA will stay up

..0. = More Data: No data buffered

.0.. = WEP flag: WEP is disabled

0... = Order flag: Not strictly ordered

Duration: 0

Destination address: ff:ff:ff:ff:ff:ff (Broadcast)

Source address: 00:0e:35:6e:20:39 (10.0.0.11)

BSS Id: 02:0e:35:00:13:ab (02:0e:35:00:13:ab)

Fragment number: 0

Sequence number: 46

Beacon Frame – Part 2

IEEE 802.11 wireless LAN management frame

Fixed parameters (12 bytes)

Timestamp: 0x00000000000019256

Beacon Interval: 0.102400 [Seconds]

Capability Information: 0x0022

....0 = ESS capabilities: Transmitter is a STA

....1. = IBSS status: Transmitter belongs to an IBSS

.... 00.. = CFP participation capabilities: Station is not CF-Pollable (0x0000)

....0 = Privacy: AP/STA cannot support WEP

....1. = Short Preamble: Short preamble allowed

....0.. = PBCC: PBCC modulation not allowed

.... 0... = Channel Agility: Channel agility not in use

.... .0.. = Short Slot Time: Short slot time not in use

..0. = DSSS-OFDM: DSSS-OFDM modulation not allowed

Beacon Frame – Part 3

Tagged parameters (46 bytes)

Tag Number: 0 (SSID parameter set)

Tag length: 9

Tag interpretation: WNLABTEST

Tag Number: 1 (Supported Rates)

Tag length: 4

Tag interpretation: Supported rates: 1.0(B) 2.0(B) 5.5(B) 11.0(B) [Mbit/sec]

Tag Number: 3 (DS Parameter set)

Tag length: 1

Tag interpretation: Current Channel: 9

Tag Number: 6 (IBSS Parameter set)

Tag length: 2

Tag interpretation: ATIM window 0x0

Tag Number: 221 (Vendor Specific)

Tag length: 7

Tag interpretation: WME IE: type 2, subtype 0, version 1, parameter set 0

Tag Number: 42 (ERP Information)

Tag length: 1

Tag interpretation: ERP info: 0x0 (no Non-ERP STAs, do not use protection, long preambles)

Tag Number: 50 (Extended Supported Rates)

Tag length: 8

Tag interpretation: Supported rates: 6.0 9.0 12.0 18.0 24.0 36.0 48.0 54.0 [Mbit/sec]

Probe Response

- ❑ When a new station ask to join the network, it starts sending the frame *Probe Request*
- ❑ The first station answers with a frame Probe Response destined to the new station

Probe Response – Part 1

Frame 147 (82 bytes on wire, 82 bytes captured)

IEEE 802.11

Type/Subtype: Probe Response (5)

Frame Control: 0x0050 (Normal)

Version: 0

Type: Management frame (0)

Subtype: 5

Flags: 0x0

DS status: Not leaving DS or network is operating in AD-HOC mode (To DS: 0
From DS: 0) (0x00)

.... .0.. = More Fragments: This is the last fragment

.... 0... = Retry: Frame is not being retransmitted

...0 = PWR MGT: STA will stay up

..0. = More Data: No data buffered

.0.. = WEP flag: WEP is disabled

0... = Order flag: Not strictly ordered

Duration: 314

Destination address: 00:0b:cd:8d:30:3b (10.0.0.10)

Source address: 00:0e:35:6e:20:39 (10.0.0.11)

BSS Id: 02:0e:35:00:13:ab (02:0e:35:00:13:ab)

Fragment number: 0

Sequence number: 143

Probe Response – Part 2

IEEE 802.11 wireless LAN management frame

Fixed parameters (12 bytes)

Timestamp: 0x000000000920D3E

Beacon Interval: 0.102400 [Seconds]

Capability Information: 0x0022

.... .0 = ESS capabilities: Transmitter is a STA

.... ..1. = IBSS status: Transmitter belongs to an IBSS

.... ..00.. = CFP participation capabilities: Station is not CF-

Pollable (0x0000)

.... .0 = Privacy: AP/STA cannot support WEP

.... ..1. = Short Preamble: Short preamble allowed

.... ..0.. = PBCC: PBCC modulation not allowed

.... 0... = Channel Agility: Channel agility not in use

.... .0.. = Short Slot Time: Short slot time not in use

..0. = DSSS-OFDM: DSSS-OFDM modulation not allowed

Probe Response – Part 3

Tagged parameters (46 bytes)

Tag Number: 0 (SSID parameter set)

Tag length: 9

Tag interpretation: WNLABTEST

Tag Number: 1 (Supported Rates)

Tag length: 4

Tag interpretation: Supported rates: 1.0(B) 2.0(B) 5.5(B) 11.0(B) [Mbit/sec]

Tag Number: 3 (DS Parameter set)

Tag length: 1

Tag interpretation: Current Channel: 9

Tag Number: 6 (IBSS Parameter set)

Tag length: 2

Tag interpretation: ATIM window 0x0

Tag Number: 221 (Vendor Specific)

Tag length: 7

Tag interpretation: WME IE: type 2, subtype 0, version 1, parameter set 0

Tag Number: 42 (ERP Information)

Tag length: 1

Tag interpretation: ERP info: 0x0 (no Non-ERP STAs, do not use protection, long preambles)

Tag Number: 50 (Extended Supported Rates)

Tag length: 8

Tag interpretation: Supported rates: 6.0 9.0 12.0 18.0 24.0 36.0 48.0 54.0 [Mbit/sec]

Data Frame

- ❑ Substantially identical to those of an infrastructured wireless network
- ❑ Note as the BSSID is always the one transmitted in the *Beacon Frames*

Data Frame – Part 1

Frame 361 (92 bytes on wire, 92 bytes captured)

IEEE 802.11

Type/Subtype: Data (32)

Frame Control: 0x0008 (Normal)

Version: 0

Type: Data frame (2)

Subtype: 0

Flags: 0x0

DS status: Not leaving DS or network is operating in AD-HOC mode (To DS: 0
From DS: 0) (0x00)

.... .0.. = More Fragments: This is the last fragment

.... 0... = Retry: Frame is not being retransmitted

...0 = PWR MGT: STA will stay up

..0. = More Data: No data buffered

.0.. = WEP flag: WEP is disabled

0... = Order flag: Not strictly ordered

Duration: 258

Destination address: 00:0e:35:6e:20:39 (10.0.0.11)

Source address: 00:0b:cd:8d:30:3b (10.0.0.10)

BSS Id: 02:0e:35:00:13:ab (02:0e:35:00:13:ab)

Fragment number: 0

Sequence number: 111

Logical-Link Control

Internet Protocol, Src Addr: 10.0.0.10 (10.0.0.10), Dst Addr: 10.0.0.11 (10.0.0.11)

Data Frame – Part 2

Internet Control Message Protocol

Type: 8 (Echo (ping) request)

Code: 0

Checksum: 0x495c (correct)

Identifier: 0x0200

Sequence number: 0x0200

Data (32 bytes)

```
0000  61 62 63 64 65 66 67 68 69 6a 6b 6c 6d 6e 6f 70  abcdefghijklmnop
0010  71 72 73 74 75 76 77 61 62 63 64 65 66 67 68 69  qrstuvwabcdefghi
```



**First Report:
Analysis of the performance
of a
Wireless Network**

First Lab Report

- You have to:
 - Describe the setup of the test
 - Describe the result obtained with schemes, examples (small dump of some significant packets), graphs and tables
 - Do a theoretical analysis of the expected results
 - Write down a short description of the data obtained and point out all the unexpected result you got!
 - **VERY IMPORTANT:** Do some analysis on the data (Average, Max, Min, Standard Deviation, ...)
 - Write some conclusions

First Report: Infrastructured

- We want to measure how the performances vary changing some parameters of the configuration of the AP
- After every modification of a parameter run N times netperf ($N > 20$, runtime > 20 sec each):
 - Analyze the data set and remove any point clearly wrong (but you have to describe the procedure you adopted)
 - Compute average, standard deviation, ...
 - It is of interest also the best result!

First Report: Infrastructured

- For our APs, you can try to:
 - Change the threshold for RTS/CTS
 - Change the threshold for fragmentation
 - Change the speed used
 - Change UDP Packet Size
 - ...

First Report: Infrastructured

- For example for a CISCO AP:

Speed 11 Mb/sec	Speed 1 Mb/sec
10.0 sec, 2.75 MBytes→ 2.30 Mbits/sec	10.4 sec, 872 KBytes→ 684 Kbits/sec
10.0 sec, 3.20 MBytes→ 2.67 Mbits/sec	

- Therefore approximately:
 - Speed ratio: $11/1 = 11$
 - Performance ratio: $2.49 / 0.684 = 3.64$

First Report: Infrastructured

- For Fragmentation: choose the threshold so that you have:
 - No – fragmentation
 - 2 fragments
 - 3 fragments
 - ...
- For CTS/RTS threshold, you have just to enable/disable it

First Report: Setup

- Use Backtrack & Wireshark to verify the setup of the testbed
 - The setup of the speed in both directions
 - The packet size using fragmentation, verifying MTU, netperf parameters, ...
 - The RTS/CTS

First Report: Setup

- Run backtrack on a laptop used as *control station*
- Run wireshark and start to acquire data from the wireless interface. As an example:
 - Observe the missing data/problems of the tools
 - Fix the speed a 1/2/11/54Mb
 - Acquire a good number of data frames
 - Possibly analyze the interarrival time between frames

First Lab Report: Ad-Hoc

- Performance Analysis of an Ad Hoc network:
 - Start an Ad Hoc network using two, three, four laptops
 - Run netperf server (use UDP) on one laptop and in client mode on the others, starting the clients in a “synchronized” way
 - Evaluate the performance, using one client, then two, three, four
 - How the throughput decrease?

First Lab Report: Ad-Hoc

□ Interferences between channels:

- Take 4 laptops and start 2 different Ad Hoc network on 2 different channels (i.e.: 1 and 7)
- Run 2 netperf server (suggestion: use UDP) on one laptop for both Ad Hoc Network, and in client mode on the others two, starting the clients in a "synchronized" way
- Evaluate the performance
- Change the channels of one of the Ad Hoc network choosing a channel closer to the other (i.e.: 1 and 6, than 1 and 5, ..., than 1 and 1), and repeat the evaluation

First Lab Report: other ideas

□ Play with MTU:

- Start an Ad Hoc network using two laptops
- Modify the MTU parameters on the wireless card (like: 1500 on both, 250 on both, 2500 and 250, 2500 and 512, ...)
- Run netperf (suggestion: use UDP) in server mode on one laptop and netperf as client on the second evaluating the throughput

First Lab Report: other ideas

- Use a laptop to acquire the packets, using wireshark and monitor mode, so you can:
 - Verify the speeds of the packet sent and received
 - Verify the packet size running iperf (server/client)
 - Change the MTU of the laptops and verify the packet size and the performance
 - Change the fragmentation threshold and verify the packet size and the performance

First Lab Report

- We will put on the website some good reports of the previous years
- We will put online a latex template