

Nomadic Communications

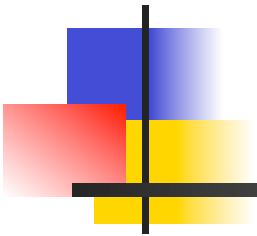

UNIVERSITÀ DEGLI STUDI DI TRENTO



Renato Lo Cigno

LoCigno@disi.unitn.it - Tel: 2026

Alessandro Villani

avillani@science.unitn.it – Tel: 1592

Dipartimento di Ingegneria e Scienza dell'Informazione

Home Page: <http://isi.unitn.it/locigno/index.php/teaching-duties/nomadic-communications>

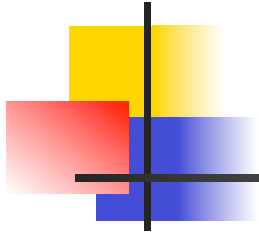

Copyright

Quest'opera è protetta dalla licenza:

Creative Commons

Attribuzione-Non commerciale-Non opere derivate

2.5 Italia License

Per i dettagli, consultare

<http://creativecommons.org/licenses/by-nc-nd/2.5/it/>





What do you find on the web site

- Exam Rules
- Exam Details ... should be on ESSE3, but ...
- Generic (useful) information
- Teaching Material: normally posted at least the day before the lesson
- Additional Material and links
- Laboratories groups, rules, description and hints
- News, Bulletin, How to find and meet me and Alessandro, etc.
- ...

The web site is work in progress and updated frequently
(that's at least my intention)

Please don't blame ME if you didn't read the last news 😊



Program

- **Why “Nomadic”**
 - Mobile vs. nomadic
 - Cellular vs. HotSpot
 - Local wireless communications
- **Some rehearsal**
 - Access Control Protocols
 - Protocols and architectures
 - Services and primitives
 - IEEE 802 project
 - Nomadic communications positioning



Program

■ **WLAN**

- 802.11 Standard
- 802.11 MAC
- 802.11b/g/a/h PHY
- QoS and Differentiation enhancement: 802.11e
- Mesh networks: 802.11s & other protocols
- Other extensions: 802.11f/n/p/...



Program

- **Ad-Hoc Networks**
 - Stand-Alone WLANs
 - Routing and multi-hop in Ad-Hoc networks
- **Personal Area Networks and WSNs**
(probably little this year)
 - Bluetooth
 - 802.15 (ZigBee)
 - Sensor and Actuator Networks
- **Vehicular Networks**
(probably quite a lot this year)
 - Problems and scenarios
 - Specific issues
 - 802.11p and WAVE



Laboratories

- Intended to be **experimental** labs
 - Hands on the material (hardware/software)
 - Configuration of devices
 - **Measurements** and results interpretation
- Centered on 802.11
 - We have material and experience
 - Devices are easy to configure and use
 - They are not meant to cover all the course material
 - They are not meant to give you **notions** but a **working methodology**



Laboratories

- We have several different experiments, but will be grouped to have only two reports, topics may include:
 - Configuring APs and measuring throughput performances
 - Identifying and Authenticating Users with Radius
 - Ad-Hoc Networking: setup and management, throughput, interference
 - Channel-level security: WEP and WPA2, identifying weak points and cracking (if possible) the security
 - ... we change specific topics from year to year
- Labs are on Mondays (14.30-18.30) and start on March 12
- Wednesdays (14.30-18.30) we have reserved a room and the mobile lab for you to work alone to complete the work and start writing the reports
- You have to group up in 2-4 students to run the experiments and write the reports
 - Groups must be defined before labs begin and are STABLE until the end of the course
 - Form the groups and notify us ASAP



Laboratories

- How to define groups:
 - talk to each other, find common interests and “presumed” exam dates (it is better, not mandatory, but better, if groups take the exam together)
 - group up in 3 (best number) or 2 or 4, “singles” are not accepted, one of the aims of the labs is also to teach you to work together
 - within **Friday March 9**, send an e-mail to Alessandro and me with the names and e-mail addresses of the group components



Laboratories

- We have reserved additional hours of the mobile lab on Wednesdays 14.30-18.30 to allow finishing experiments and measurements, Alessandro will give details on its use and rules to follow
- Lab reports are **mandatory**
- Reports are evaluated on a scale 0-16 and form roughly 50% of the exam evaluation, though not in an “algebraic” sense, e.g:
 - 12 in lab reports does not mean that you have a strict upper bound of 26
 - 16 does not mean that you will surely pass the exam
- If reports are delivered within 2 weeks from the official delivery date (defined later on by Alessandro), then Alessandro will have a look at them and advise if additional work/refinement is suggested, otherwise they go directly to me for evaluation
 - Alessandro's advices are not an evaluation, just suggestions on improvements ... so don't come to me and say “but Alessandro said it was O.K.”, that's not true by definition.



Laboratories

- The focus is on experimental science
 - Devise an experiment, find interesting “measures” and define them
 - Set it up, explain it carefully so that it is replicable – a fundamental property of science!!
 - Take data and measurements
 - Check them **quickly and immediately**, so that if there are problems additional data can be collected
 - Present results carefully, in a readable way
 - Give an interpretation of the results based on the theoretical knowledge you have

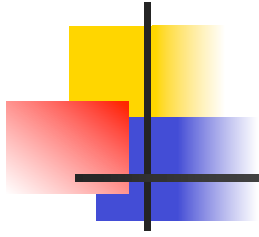

Why Nomadic

- Cellular Networks widely diffused
 - Expensive
 - Omnipresent
 - Still voice/small terminal oriented
- The Internet *while around* requires
 - Different (faster/cheaper) network
 - Don't need to use it while *moving*
 - Want to have it "*around*" but not necessarily *everywhere*

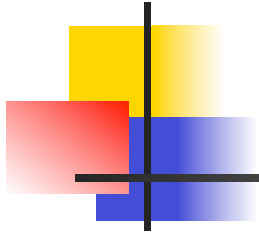

A Fundamental Difference

Wireless Network

(sub)net where the access is on a tetherless channel, can be your cordless at home!

Cellular Network

a global network where the topological coverage is obtained with a set of adjacent or overlapping areas called *cells*. The mobile terminal (user) can move from one cell to the other keeping the communication seamlessly active

Wireless Network with a Fixed Point of Access

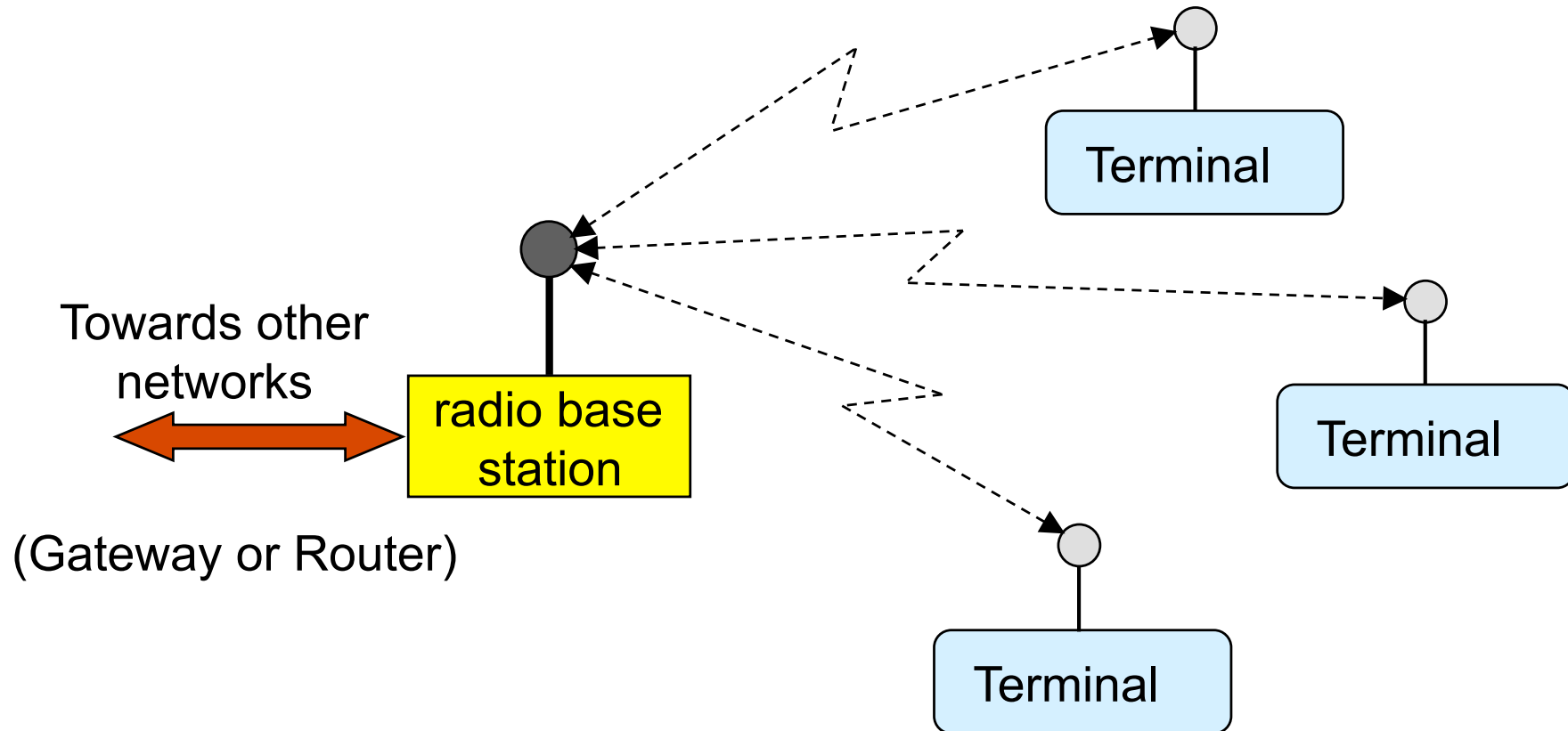

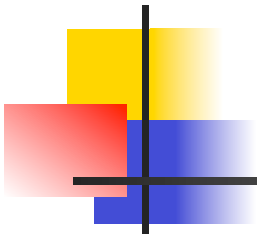

Ad-Hoc Self Configuring Wireless Network

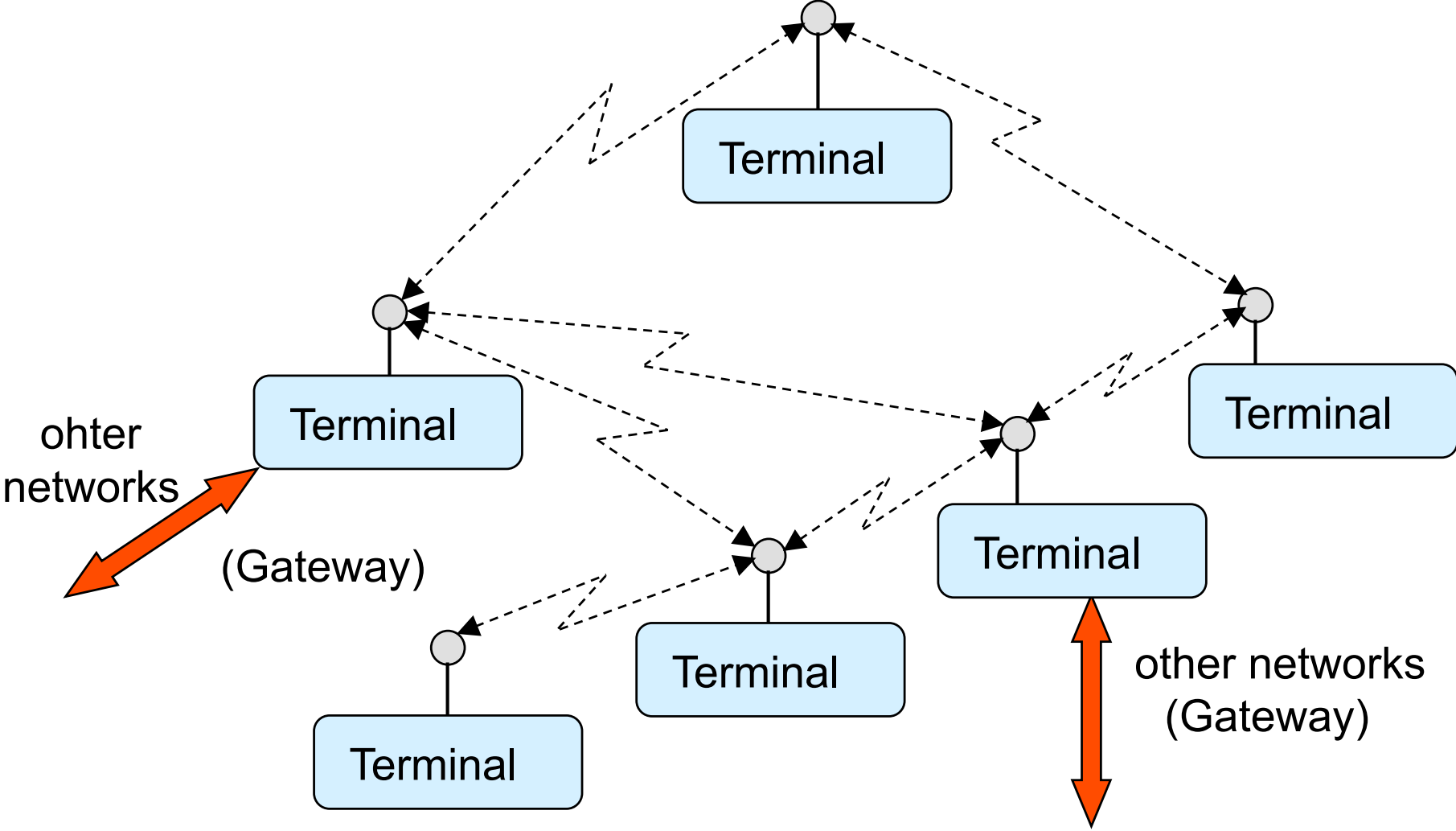

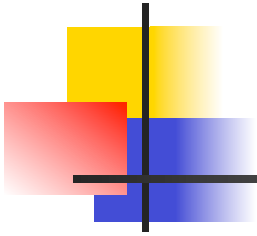

Cellular Network

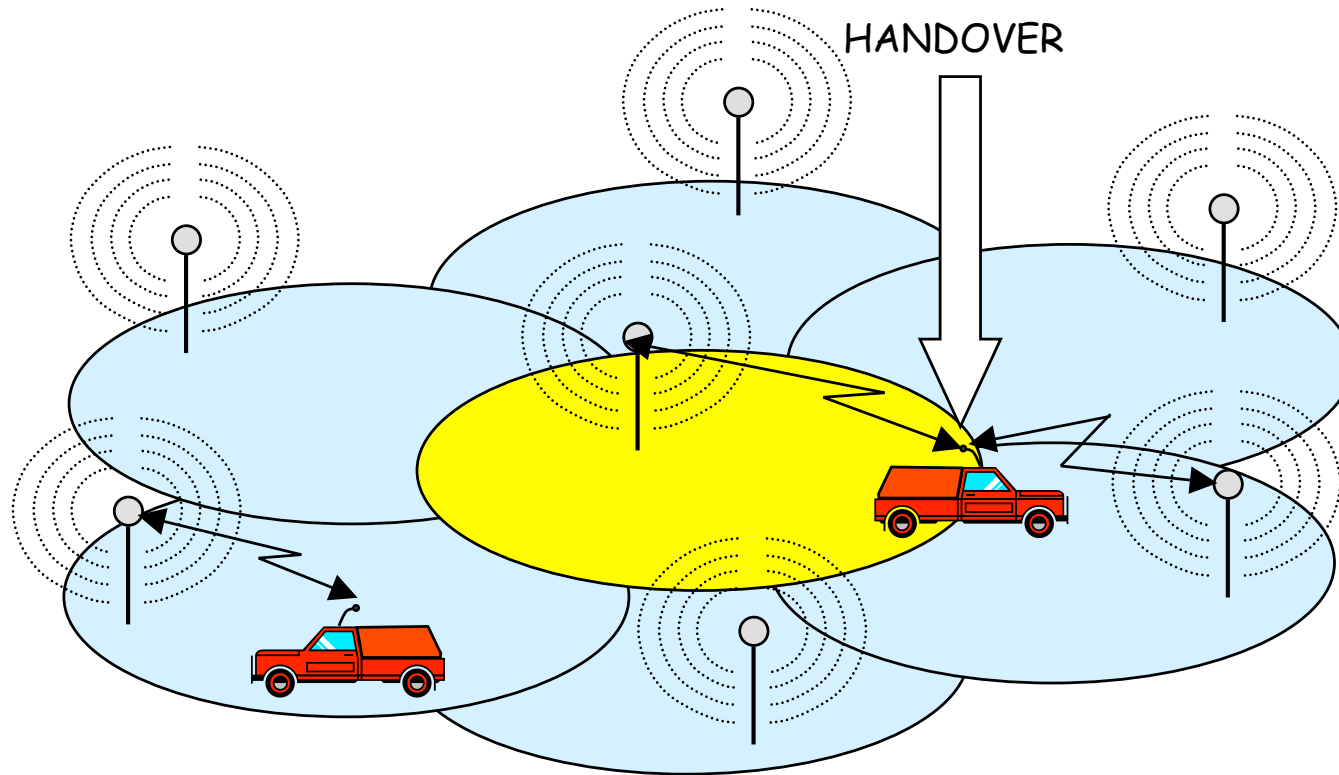



Wireless Local Access

- Nomadic communications are characterized by a first (second, third ...) wireless hop, then a connection to the global network
- Short range radio
- Normally shared medium
- Generally Best-Effort
- Need for authentication, identification, authorization (or not??)
- Warchalking is not sustainable (at least for HotSpots and professional support)



Access Protocol Rehearsal

what you *already know* but don't *remember*
what you *should know* but are not *aware of*





Classification of LAN MAC protocols

- 3 types
 - Contention or Random Access (Aloha, CSMA/CD, Ethernet)
 - Ordered Access (Token Ring, Token Bus, FDDI)
 - Slotted with reservation (DQDB, Res-Aloha)
- Evaluation/Performance Parameters
 - Throughput (capacity and carried traffic)
 - Fairness
 - Delay (access, propagation, delivery)
 - Topology, Resilience, Network dimension, Number of Stations,



Random Access Protocols

- A node in transmit a packet
 - At line speed R
 - without coordination with others
- If more than one node transmit at the same time..... \Rightarrow collision
- Random Access (or contention based) MAC protocols specify:
 - How to randomize the initial access
 - How to recognize a collision
 - How to retransmit the packet after a collision

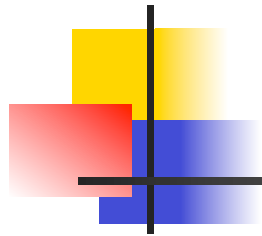

Slotted Aloha

- Time is divided in equal length slots
- Nodes transmit at the beginning of the slot only
- In case of collision retransmit either with probability p or after a random delay till success



Slotted Aloha: homework

- Compute collision probability in case of Poisson Arrivals
- Compare the p-retransmission policy with the delayed retransmission one
 - are they equal? in what conditions?



Success (S), Collision (C), Empty (E) slots

ALOHA

- Simpler, no slots no synchronization
- Transmission at any time, retransmission too, only random delay possible after collisions
- Collision probability is increased
 - yellow packet collides with other packets in $[t_0-1, t_0+1]$

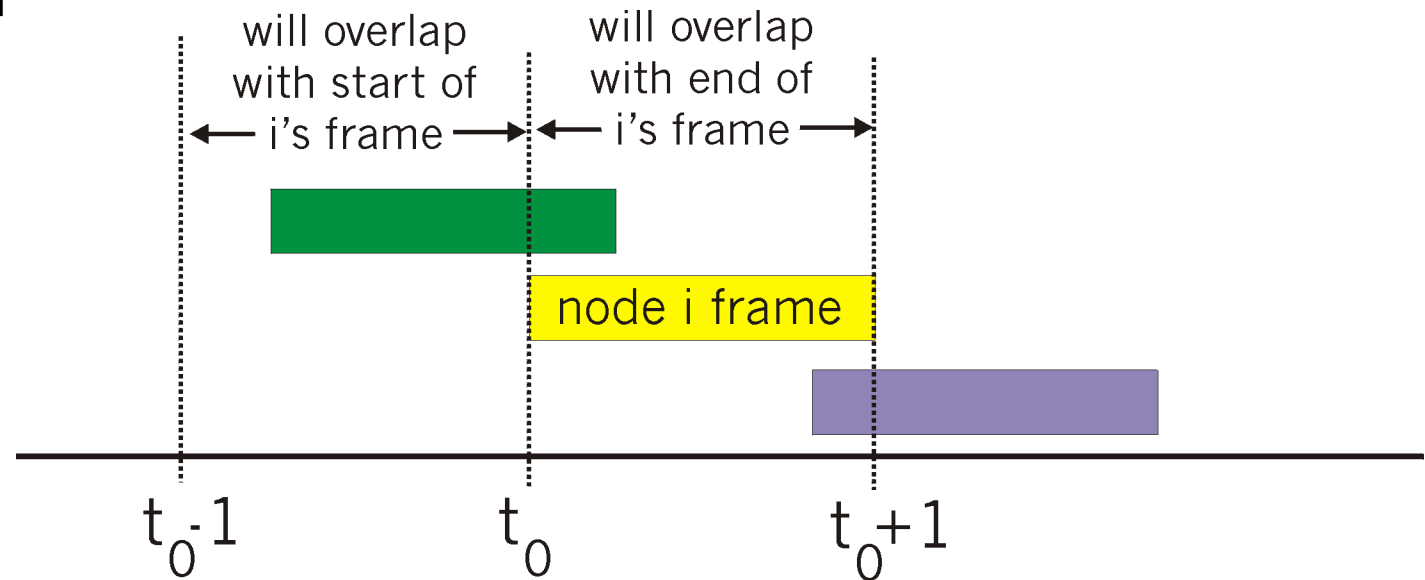

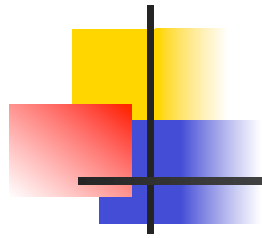

Comments

- Simple protocols
- Throughput is very limited due to collisions
 - with Poisson arrival hypotheses the maximum efficiency is
 - 18% ALOHA
 - 37% SLOTTED ALOHA
 - With other traffic may be larger/smaller
- Unstable protocols (throughput goes to zero at high loads)!!!
- At low loads access delay is close to zero
- Access delay is not guaranteed nor bounded!!



CSMA: Carrier Sense Multiple Access

- Conceived to increase throughput
- Stations listen to the channel before transmitting
 - If channel is free: Transmit Packet
 - If channel is occupied delay transmission
 - 1- persistent CSMA: Immediate transmission on free channel
 - 0-persistent CSMA: Retry after a long random delay
 - p-persistent CSMA:
 - With probability p behaves as 1-persistent
 - With probability $(1-p)$ behaves as 0-persistent

CSMA: collisions???

- May happen due to propagation delay
- Transmission time is entirely wasted
- Distance between stations plays a fundamental role in the collision probability

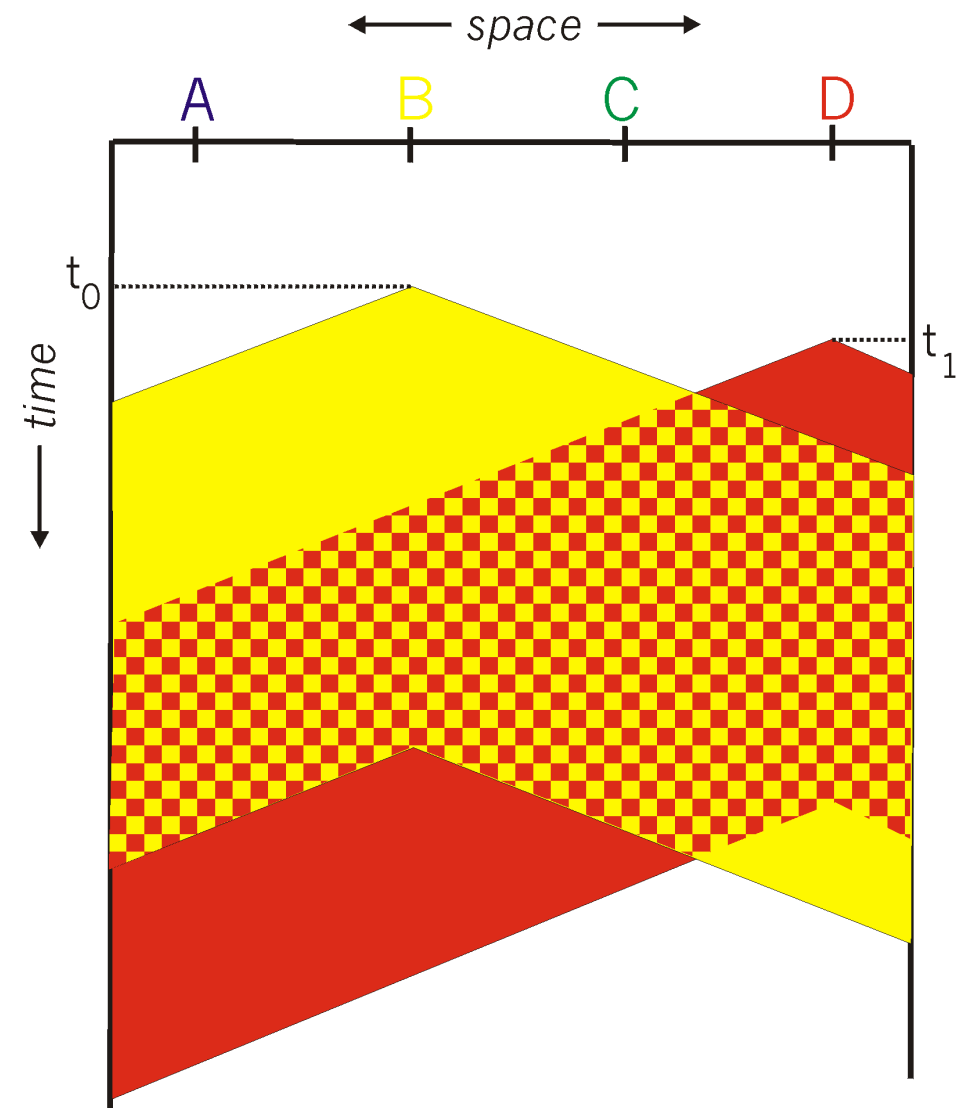



CSMA/CD (Collision Detection)

- CSMA/CD Builds on top of CSMA
 - Try to understand when a collision occurs and stop transmission
 - Wasted time is reduced
- Collision detection:
 - Easy on wired LANs: Simple power measurement with threshold comparison between transmitted and received power
 - Practically impossible in WLANs
 - Half Duplex
 - Power fluctuation/Power attenuation

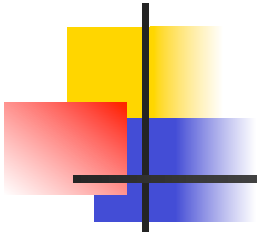

CSMA/CD collision detection

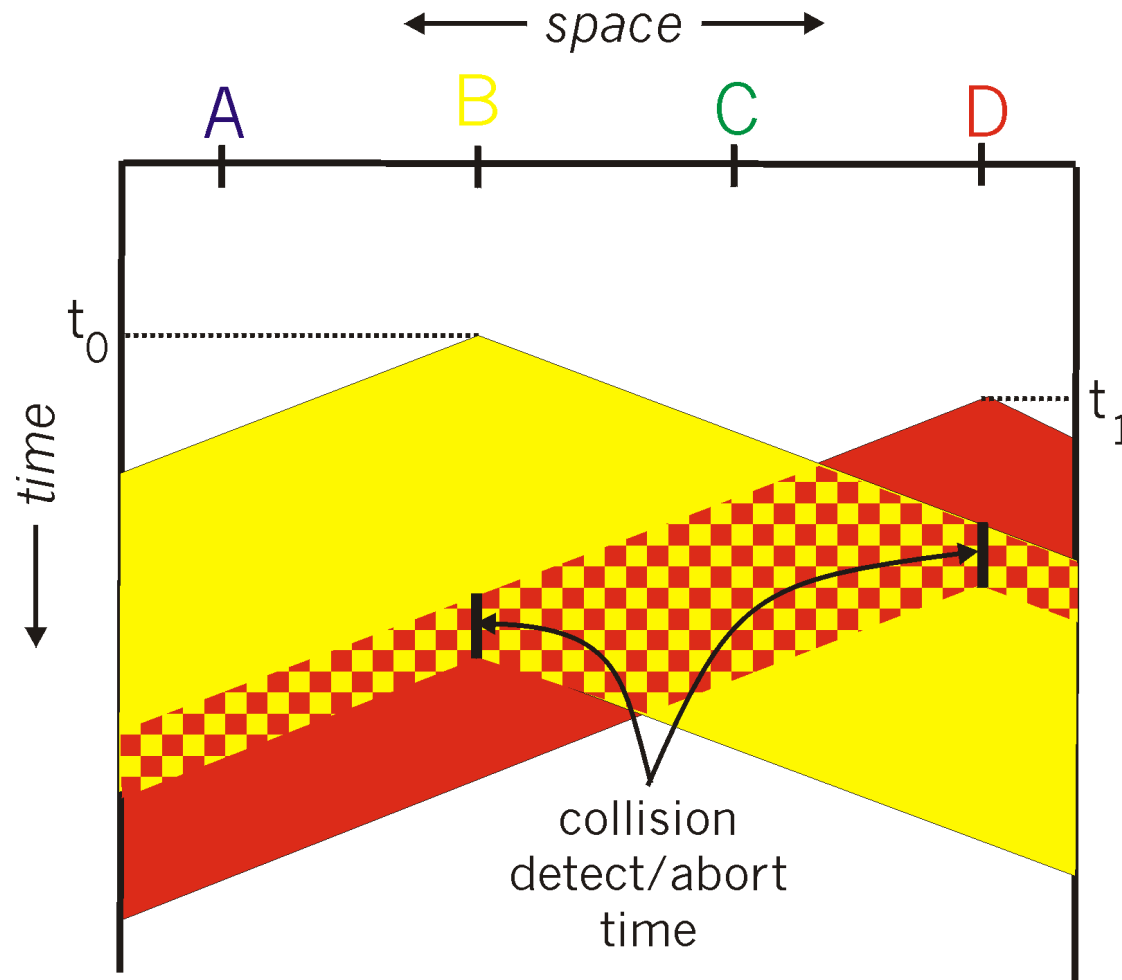



CSMA/CD: Performances

- The fundamental parameter is end to end propagation delay
 - More precisely what counts is the ration between the (average) packet transmission time and the e-t-e propagation delay
- Performances are optimal for small, slow (in terms of transmission speed) LANs with large packet dimension
- There is a minimum packet size required to identify collisions



CSMA/CD: Performances

- The 1-persistent behavior is normally preferred for the low access delay at low loads
- The protocol is instable, just like any contention based protocol without “corrections”
 - Exponential backoff on transmissions to induce stability
 - Dimension and No. of stations limits adapted to backoff
- It's not easy to introduce traffic differentiation and priority
- **This is Ethernet !!**

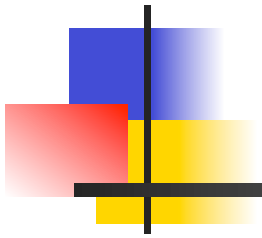

Protocols and Architectures

understand the “world” we’re moving in



Architectures & Protocols

- ITU-T & ISO definition:
 - **Communication**: information transfer following predefined conventions
- Communication require cooperation
- An abstract description of communication among two or more users requires a
reference model
- The highest level abstraction of a reference model defines a
network architecture

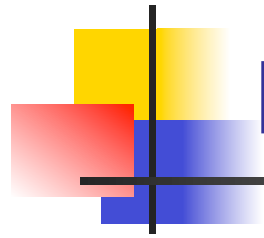

Network (Protocol) Architecture

- A network architecture defines the *objects* and *entities* used to describe:
 - The communication process
 - Relationships among these objects/entities
 - Functions required for communication
 - Organization modes of these functions
- Modern communication architectures are layered
 - Easier design
 - Easier management
 - Easier standardization and greater modularity
 - Function separation



Function separation: Internet

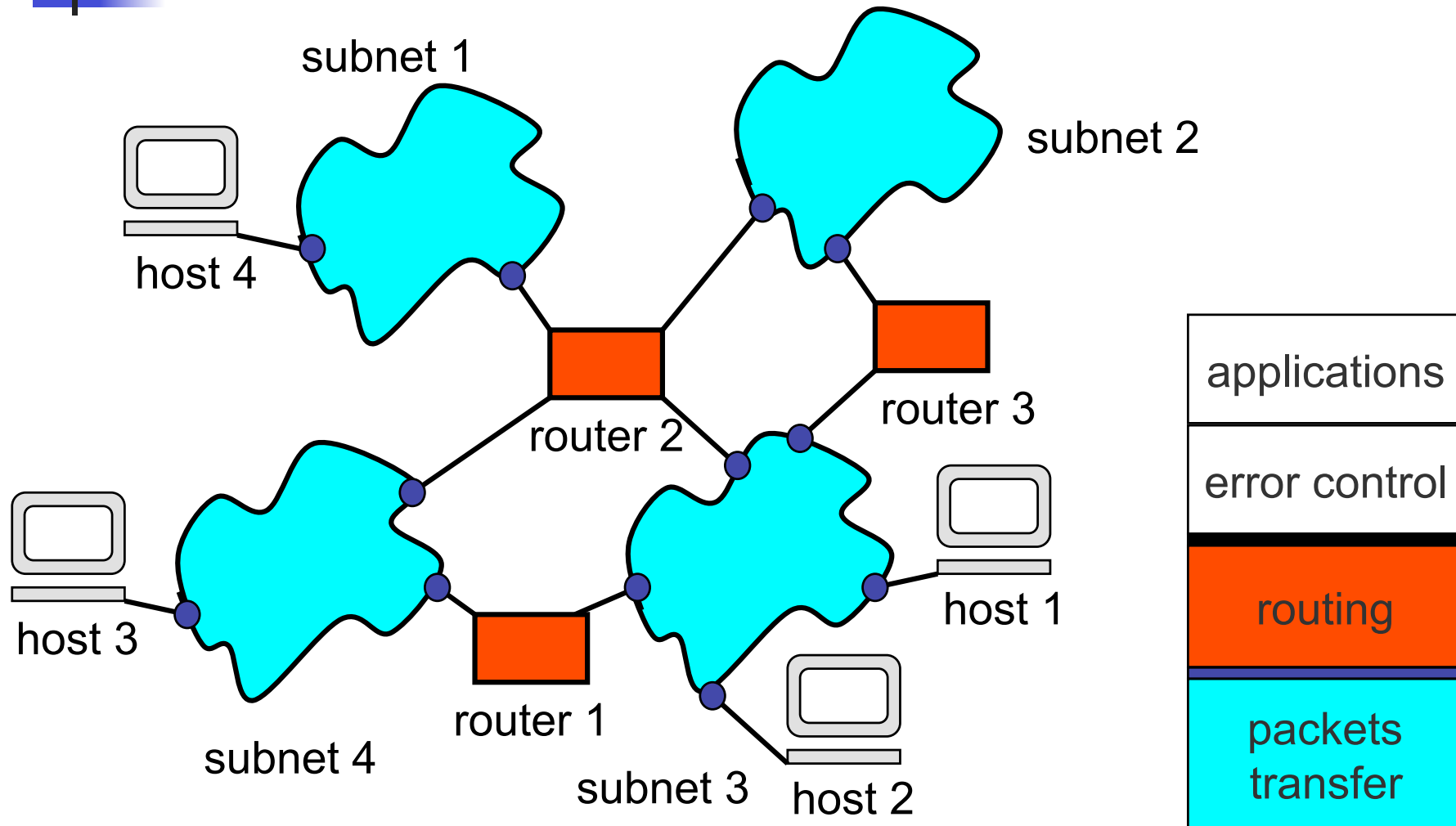



Protocols

- ITU-T & ISO definition (once again!)
 - formal description of the procedures adopted to ensure communication among two or more objects **at the same hierarchical level**
- Protocol definition (design):
 - **Semantic**
 - **The ensemble** of commands and responses
 - **Syntax**
 - **The structure** of commands and responses
 - **Timing**
 - **Temporal sequences** of commands and responses (procedures)



Protocols

- In other words:
 - Semantics
 - Algorithms
 - Syntax
 - Formats
 - Timing
 - State machines and sequential diagrams

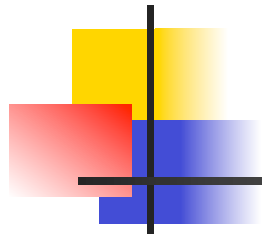

ISO/OSI reference model

- (Open System Interconnection) is today the basis (sometimes disregarded for ignorance and sometimes questioned for philosophy) for any protocol design, from the physical layer to the application layer ... to overlay structures such as web-services and peer-to-peer systems
- We are talking about **principles**, not the detailed functionalities and not even the detailed layers, objects, entities

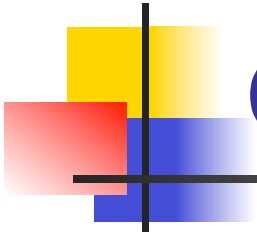

OSI Reference Model

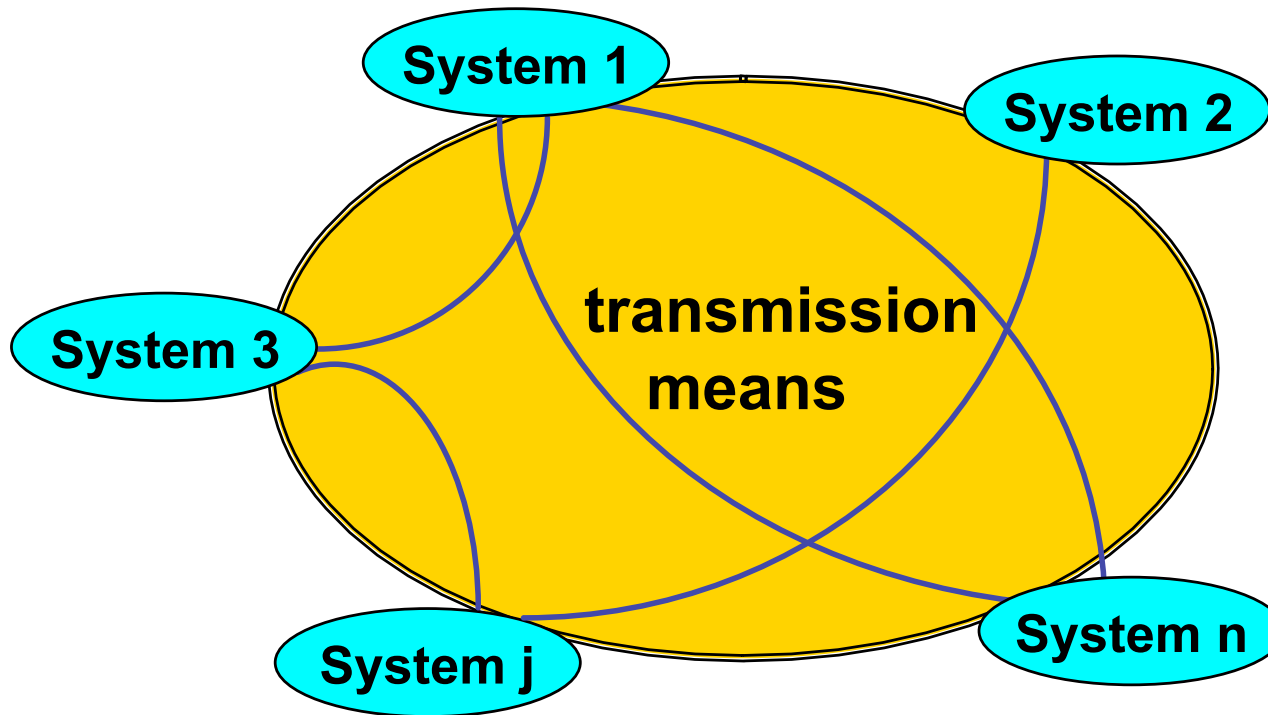

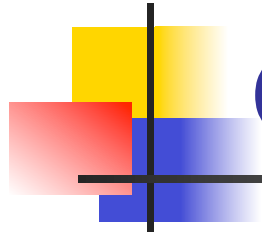

OSI Reference Model

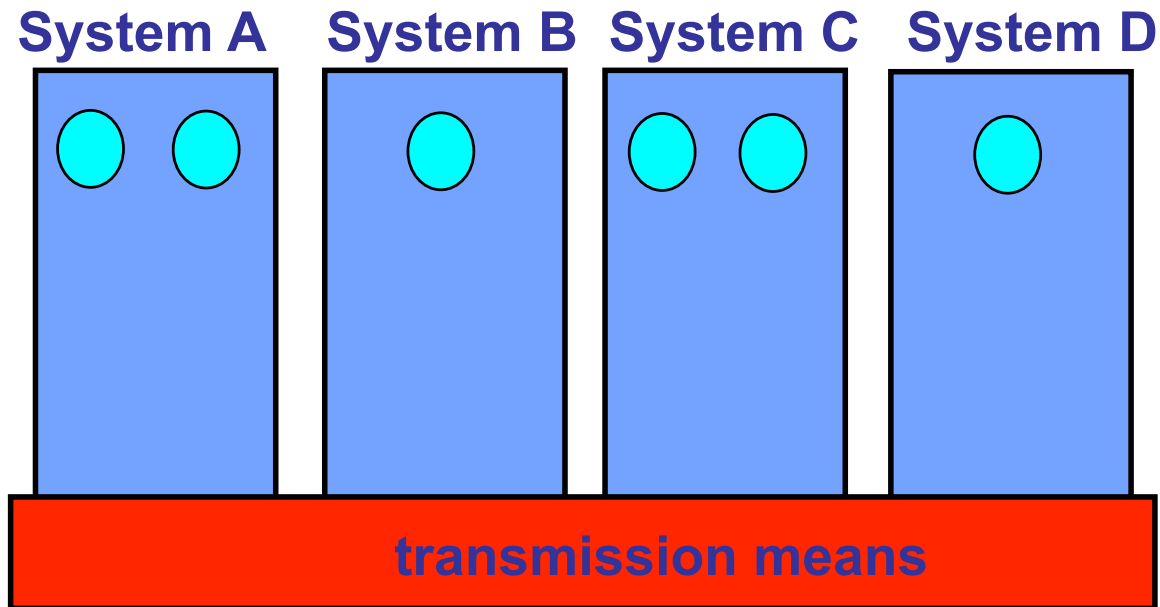

 application processes



Layers

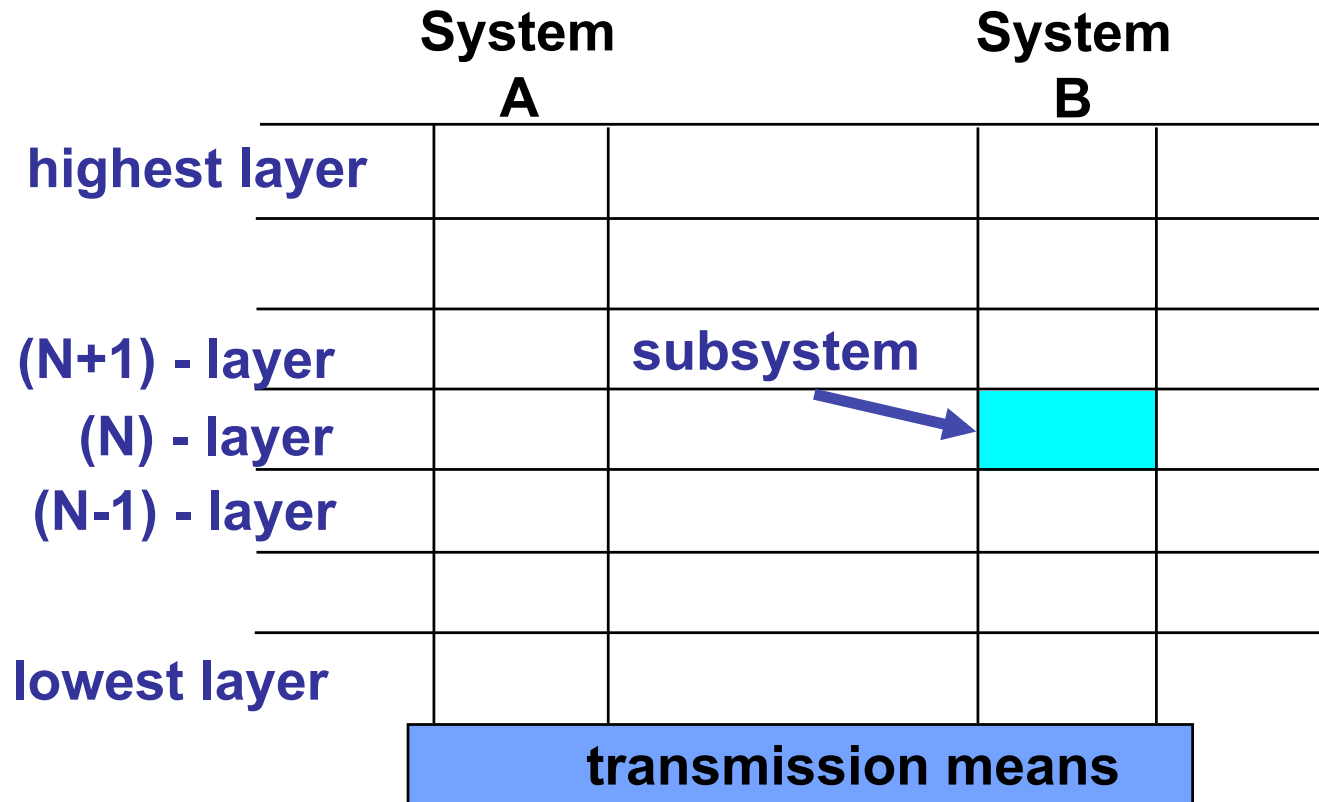

Entities

- Active elements in a sub-systems
- Fulfill layer operations
- Interact with peer entities

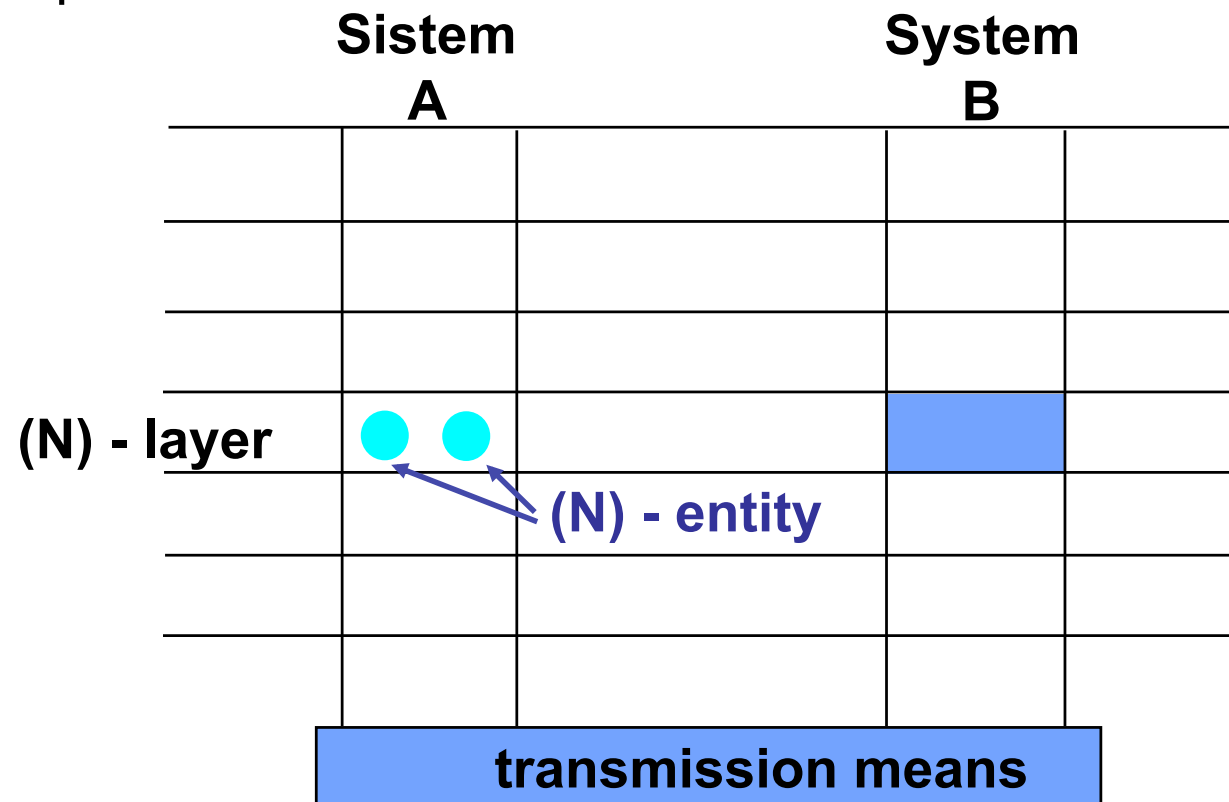



Layering

- Each Layer (N)
 - Provides services to the upper layer (N+1)
 - using
 - (N-1) Services
 - Own functions
- Identify:
 - service providers
 - service users
 - SAP (Service Access Points)

Services

- N-layer users $-(N+1)$ – entities– cooperate and communicate using the (N)-service provided by the (N)-service provider

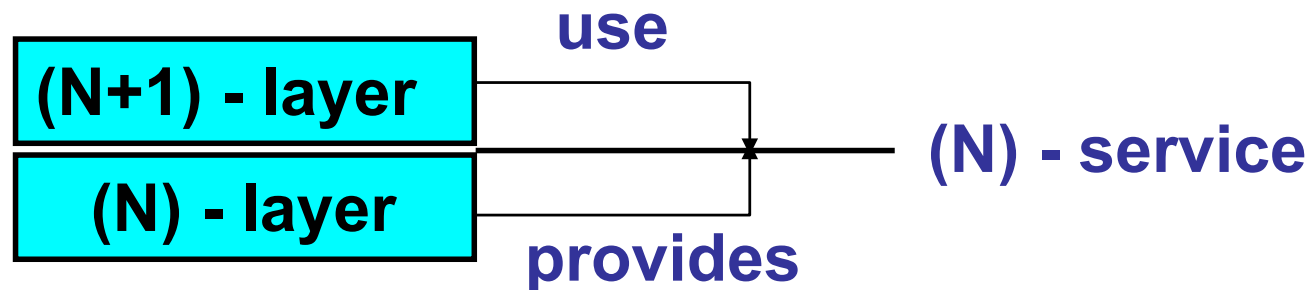

- In TCP/IP this are the "socket" between application layer protocols and TCP/UDP



Services

(N) - service

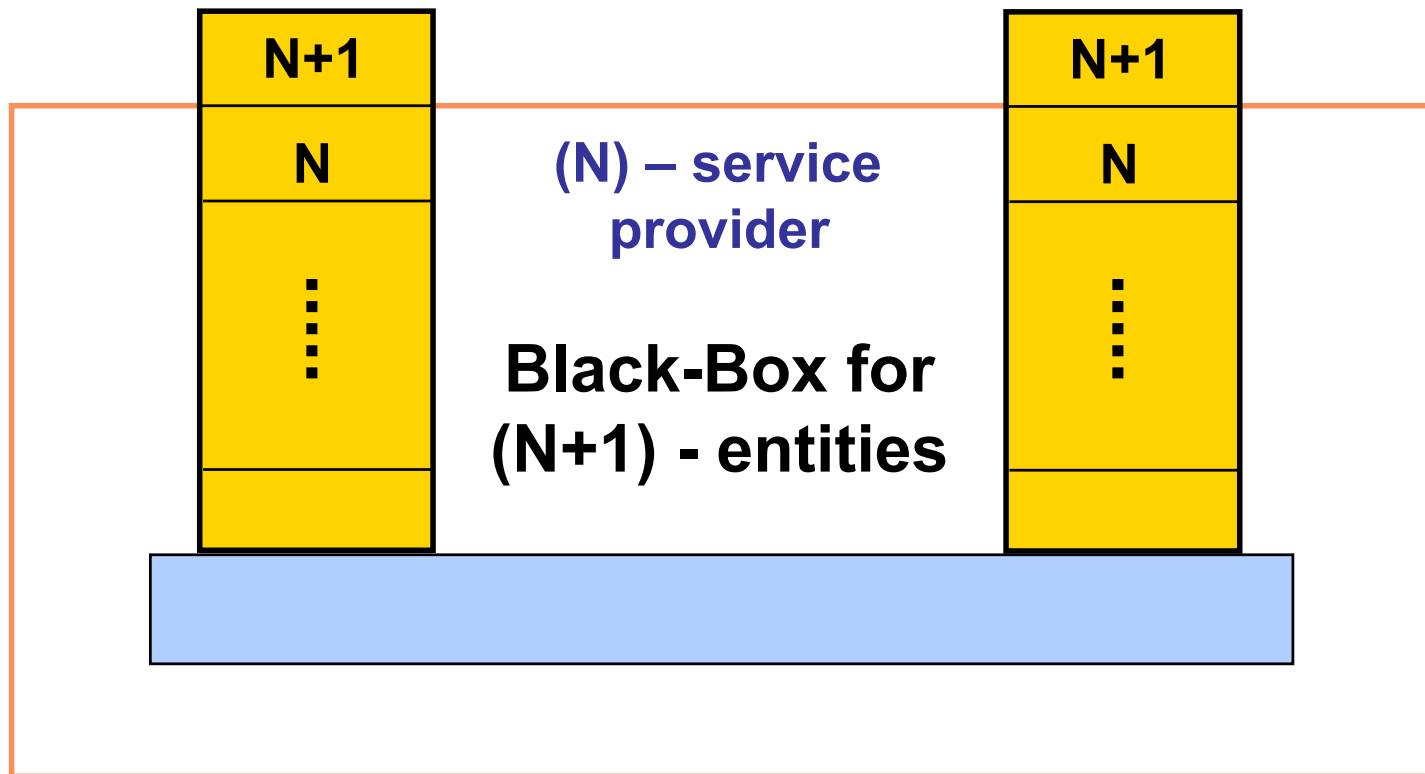

SAPs

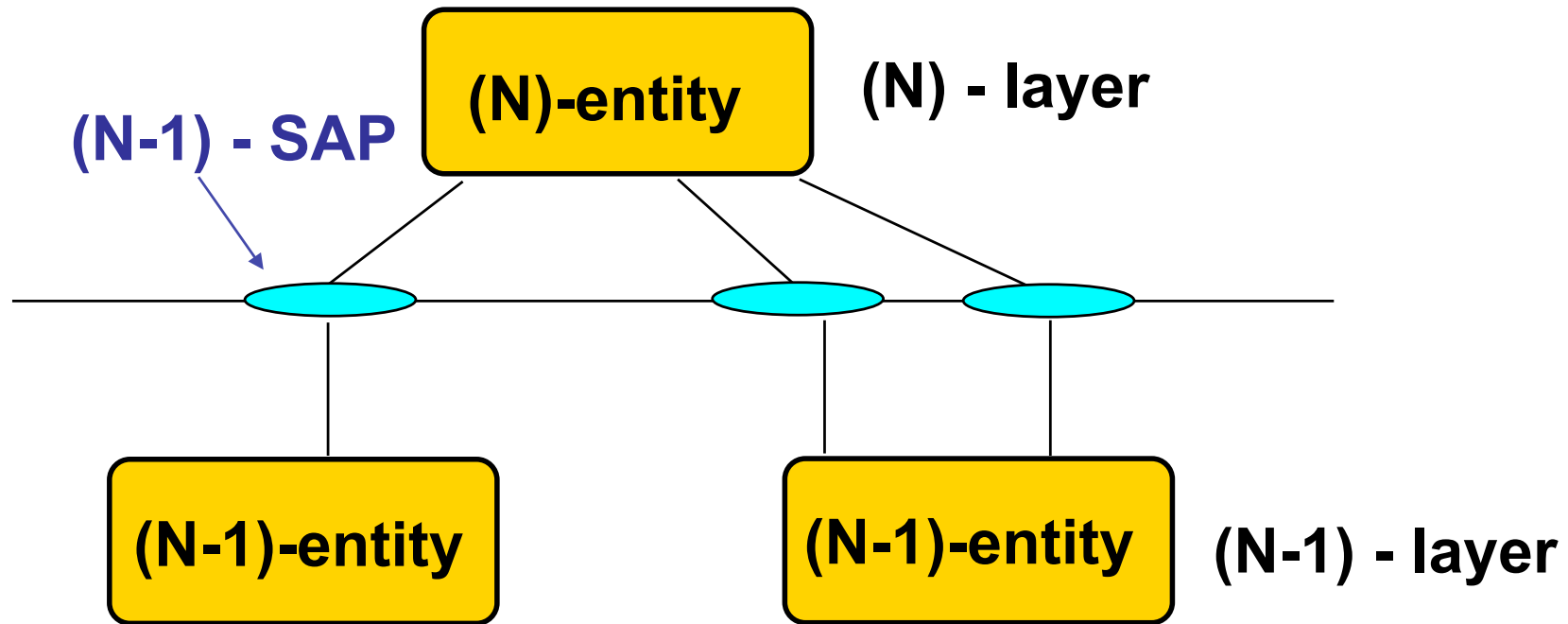

In Internet we have many different names for SAPs, from sockets to buffer to simply c-functions non formally named (e.g., the "ethernet" interface of Linux kernels)

Protocols

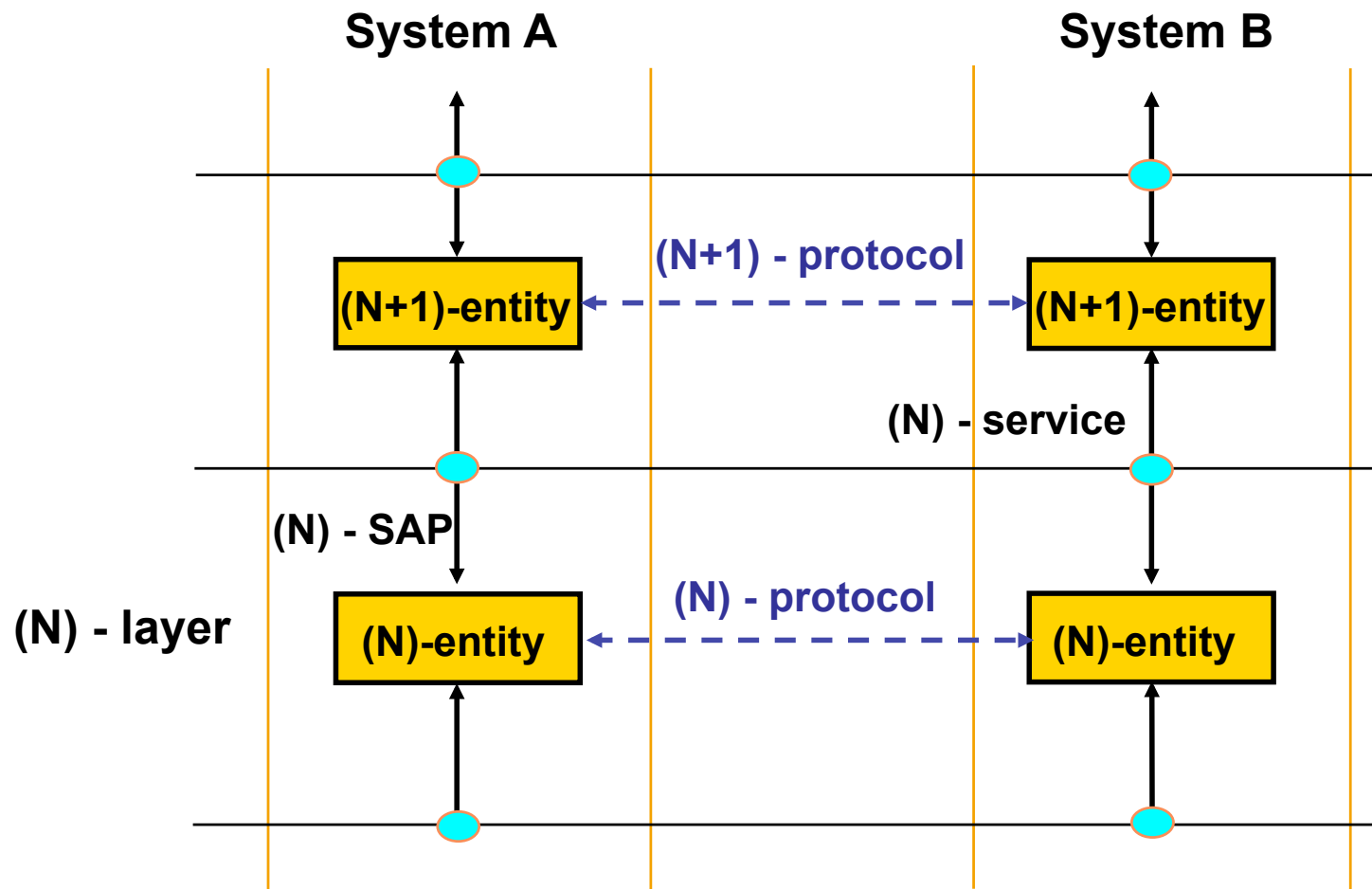

Protocol "addresses"

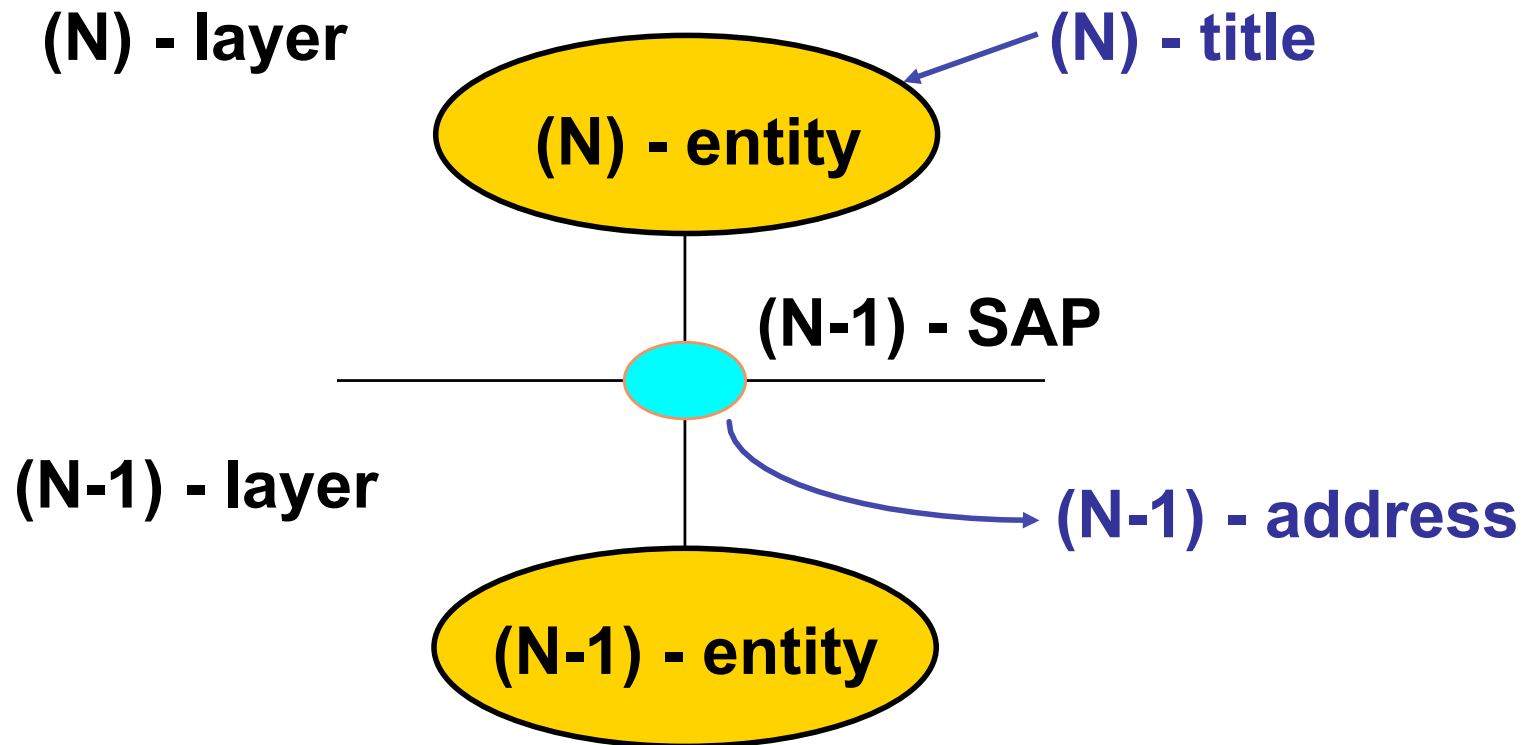

In TCP/IP addresses are named "port", "protocol", depending on the layers

Notice the differences/similarities with IP-addresses



Mapping Types

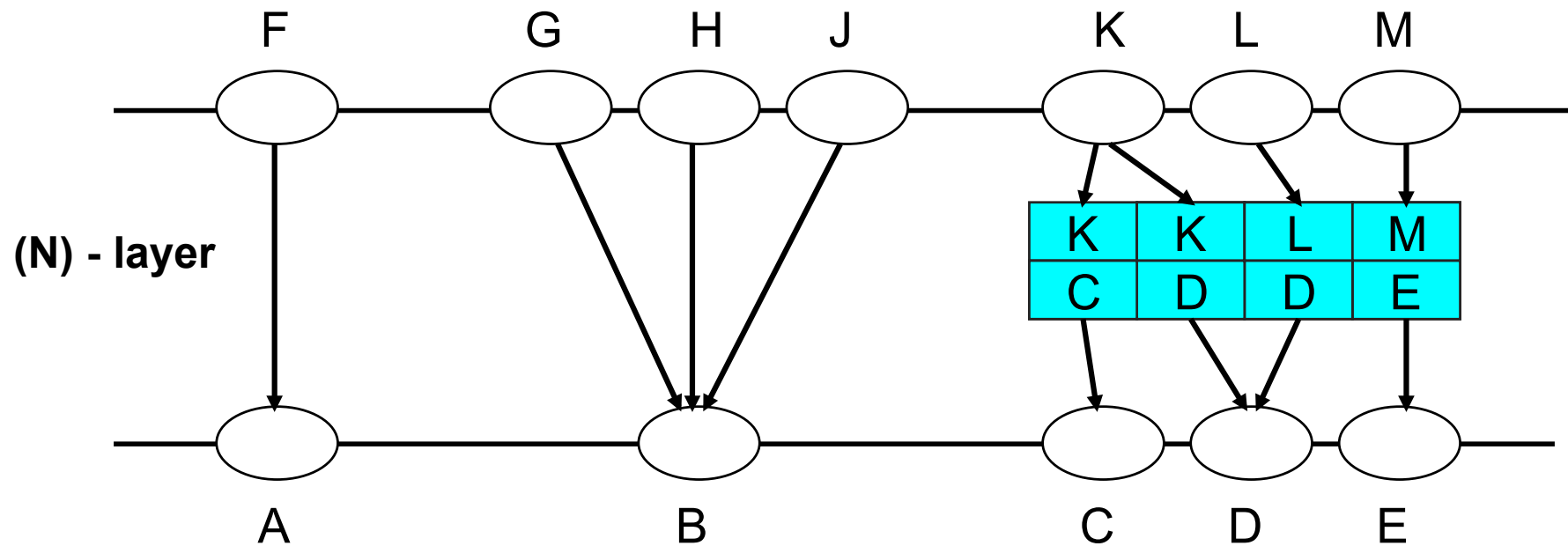

one-to-one hierarchical

tabular

Connections

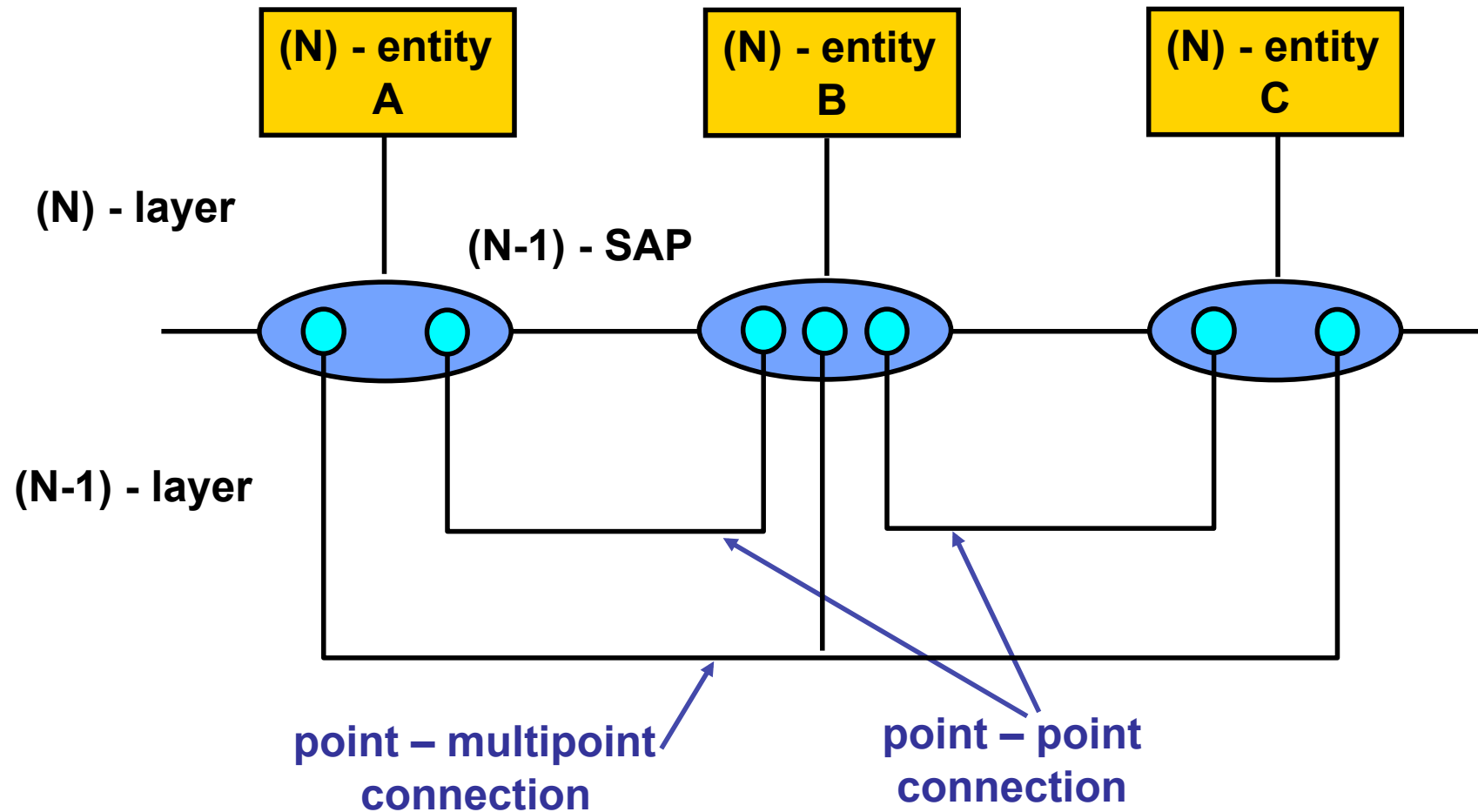

Agreements

Three parts agreement: connection oriented communications

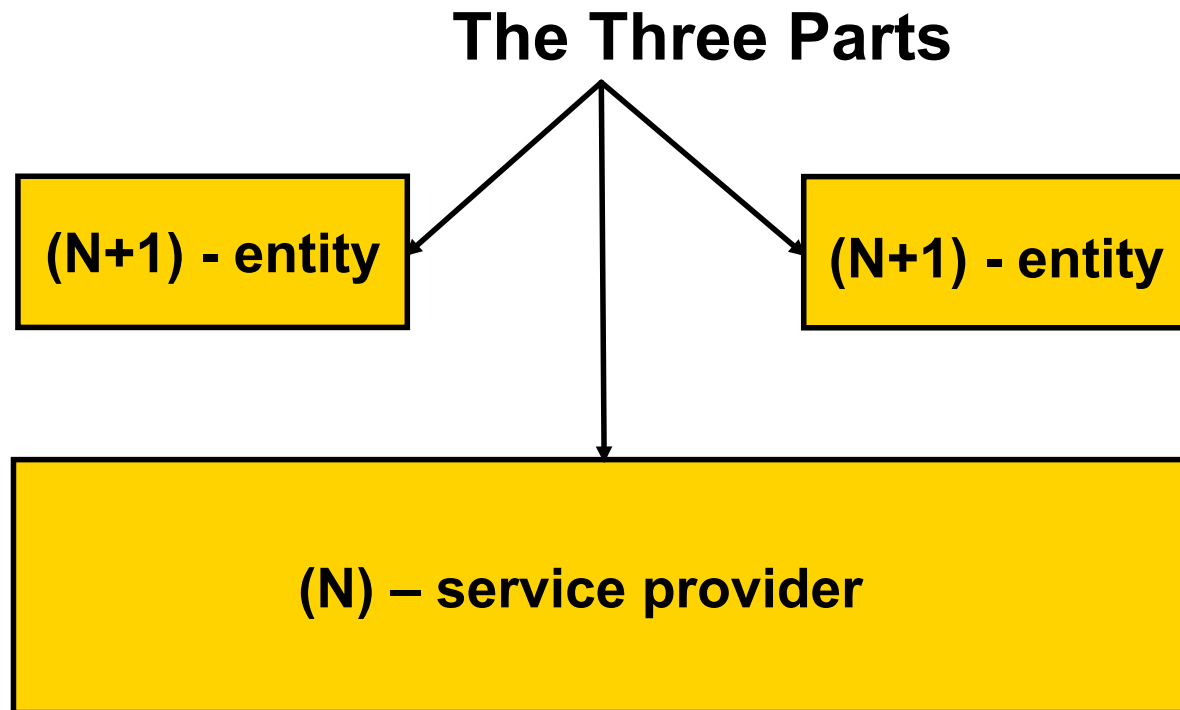

Agreements

Two parts agreement: connectionless communications

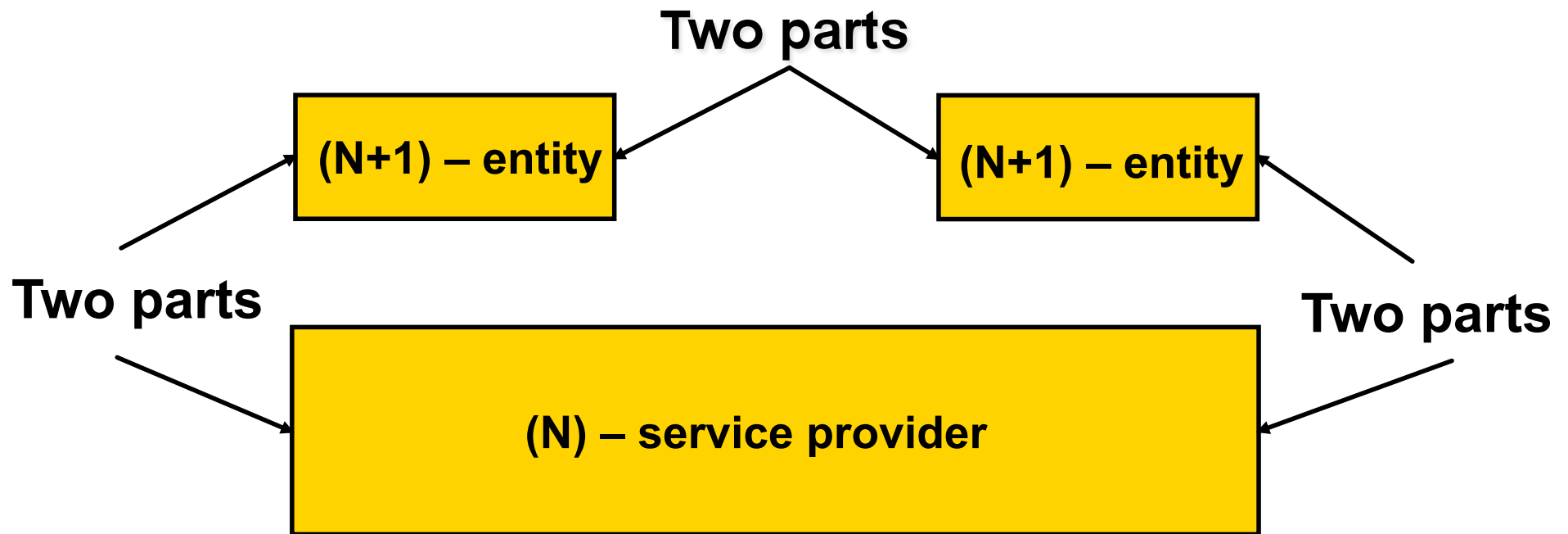

Connections

- Multiplexing (N) – connections onto a (N-1) – connection

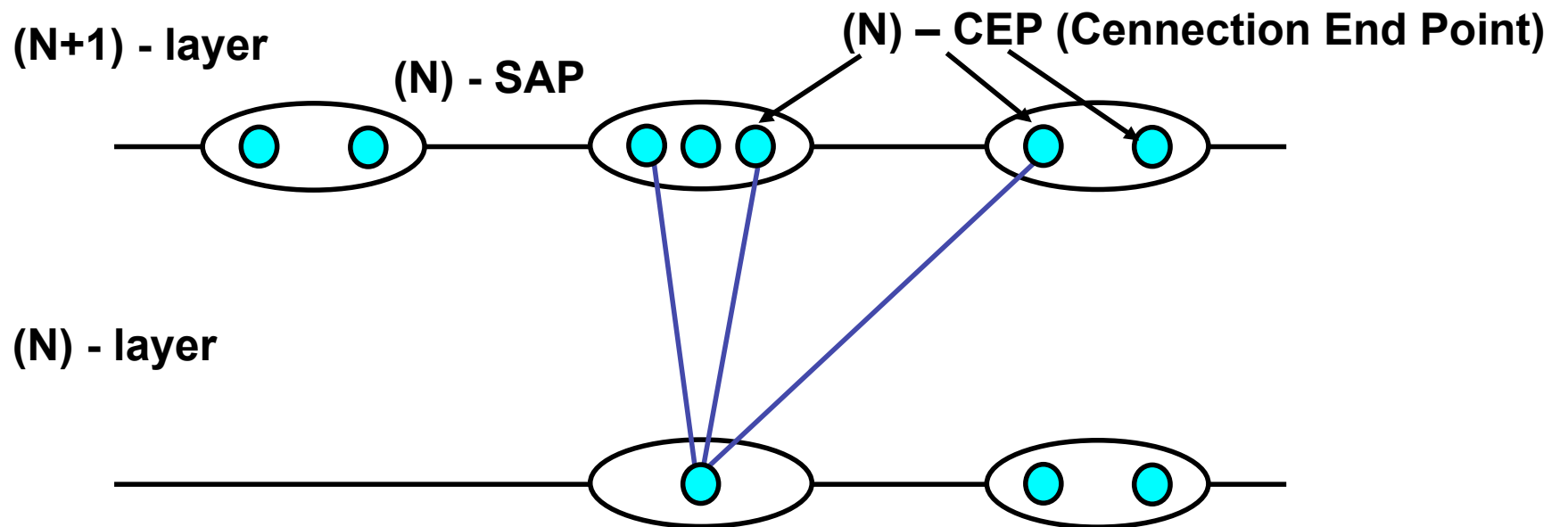

Connections

- (N) – connection splitting onto multiple (N-1) – connections

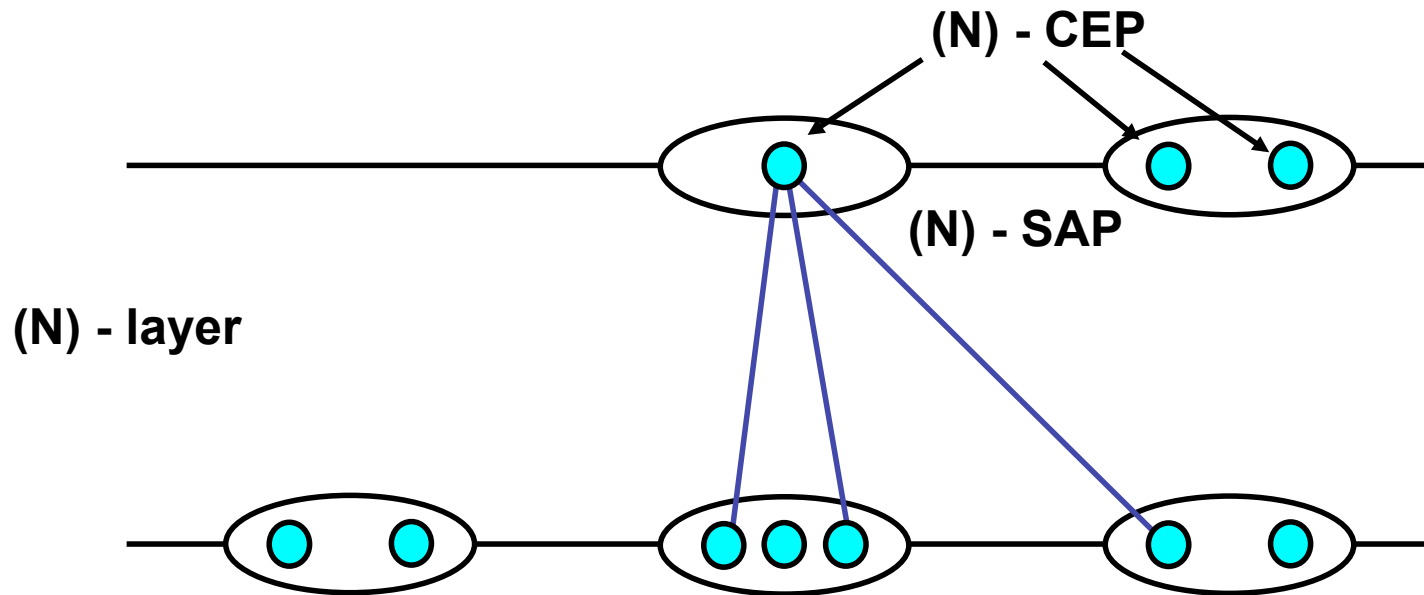

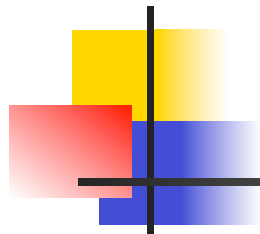

PDU Formation

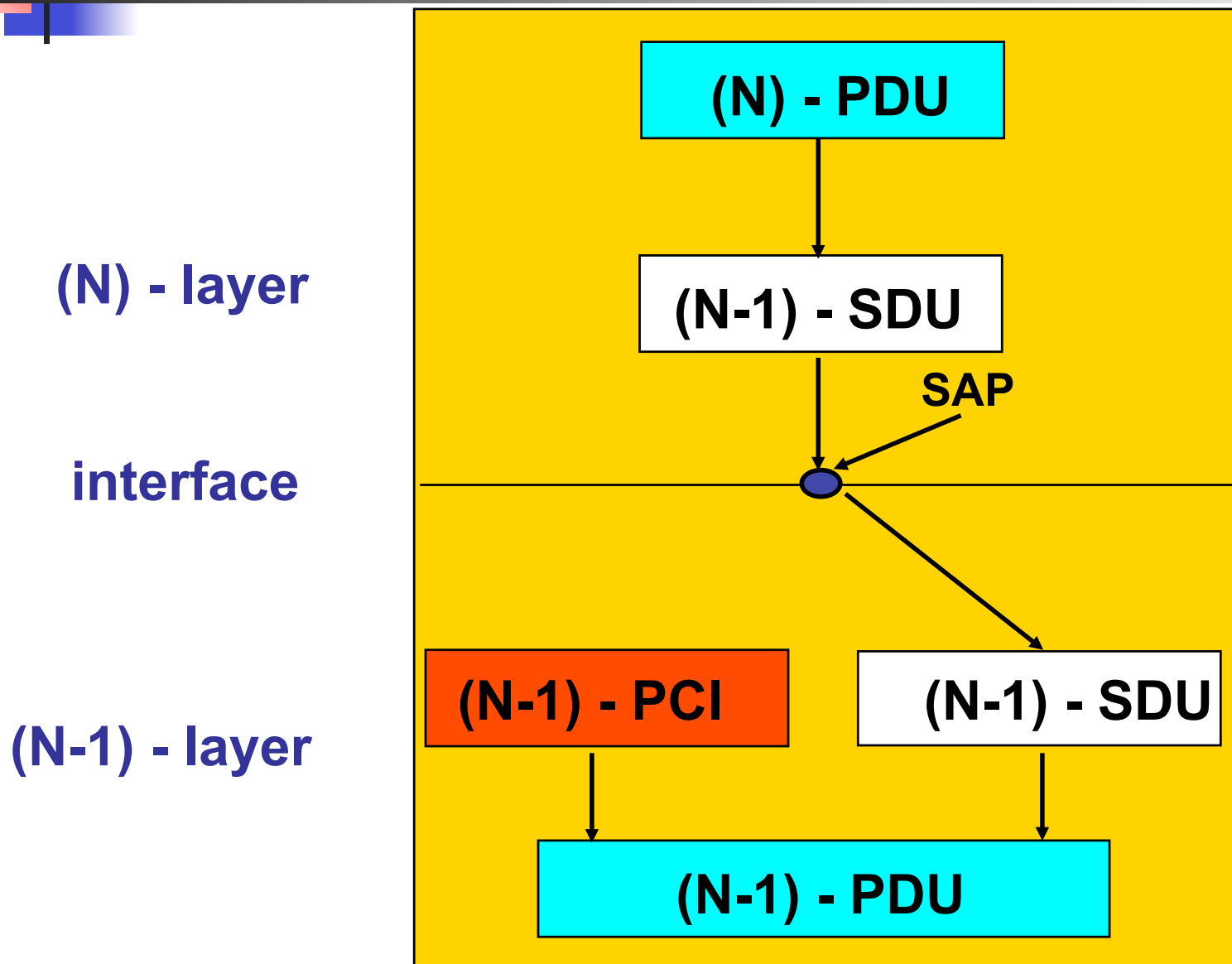



PDU Formation

- Data Units can be
 - segmented
 - concatenated
- Segmentation may follow two “paths”
 - Building more (N) - PDUs from one (N) – SDU
 - Generating more (N-1) - SDUs from one (N) - PDU
- Similarly for concatenation

- Often both processes are called segmentation for the sake of brevity

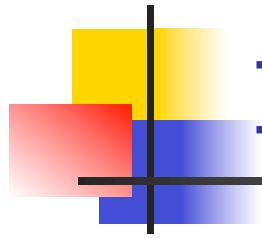

Information Transfer

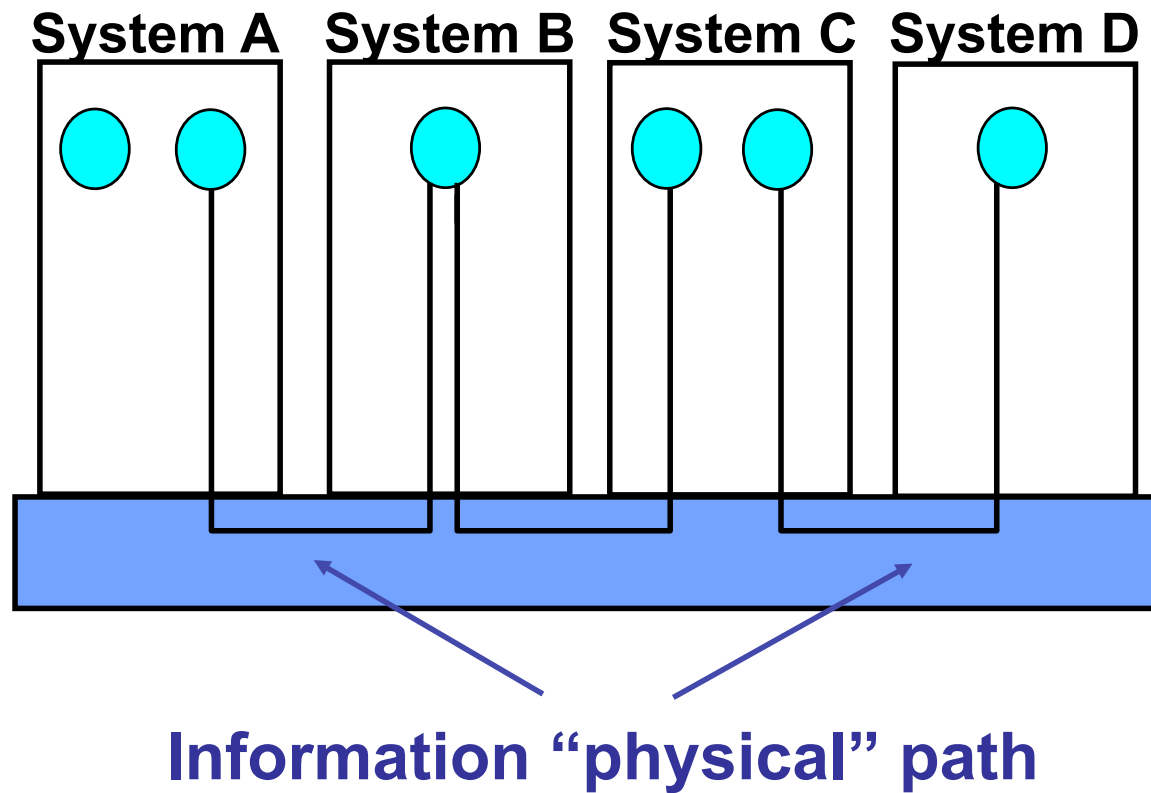

Primitives

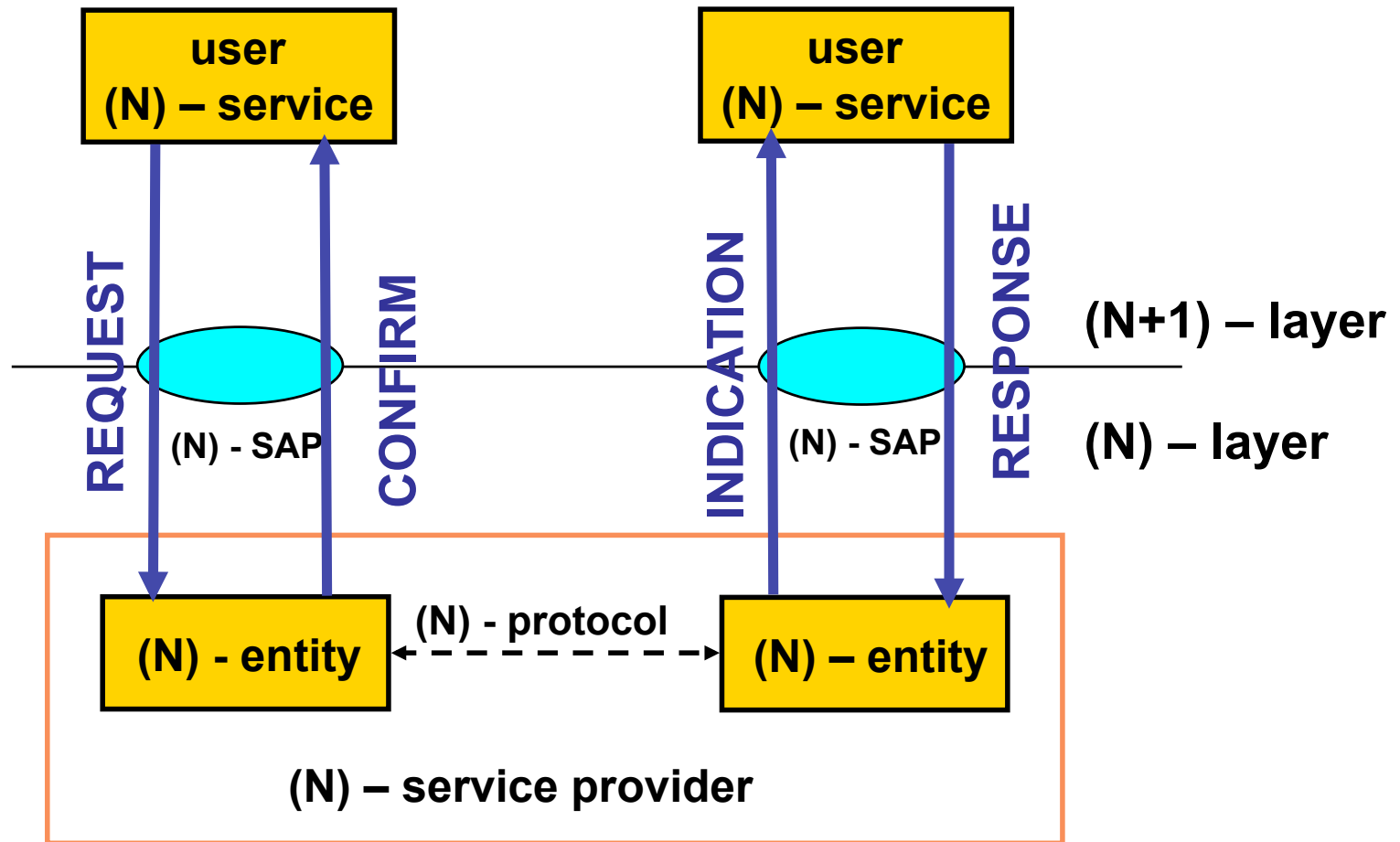

Primitives' Use

Confirmed Service

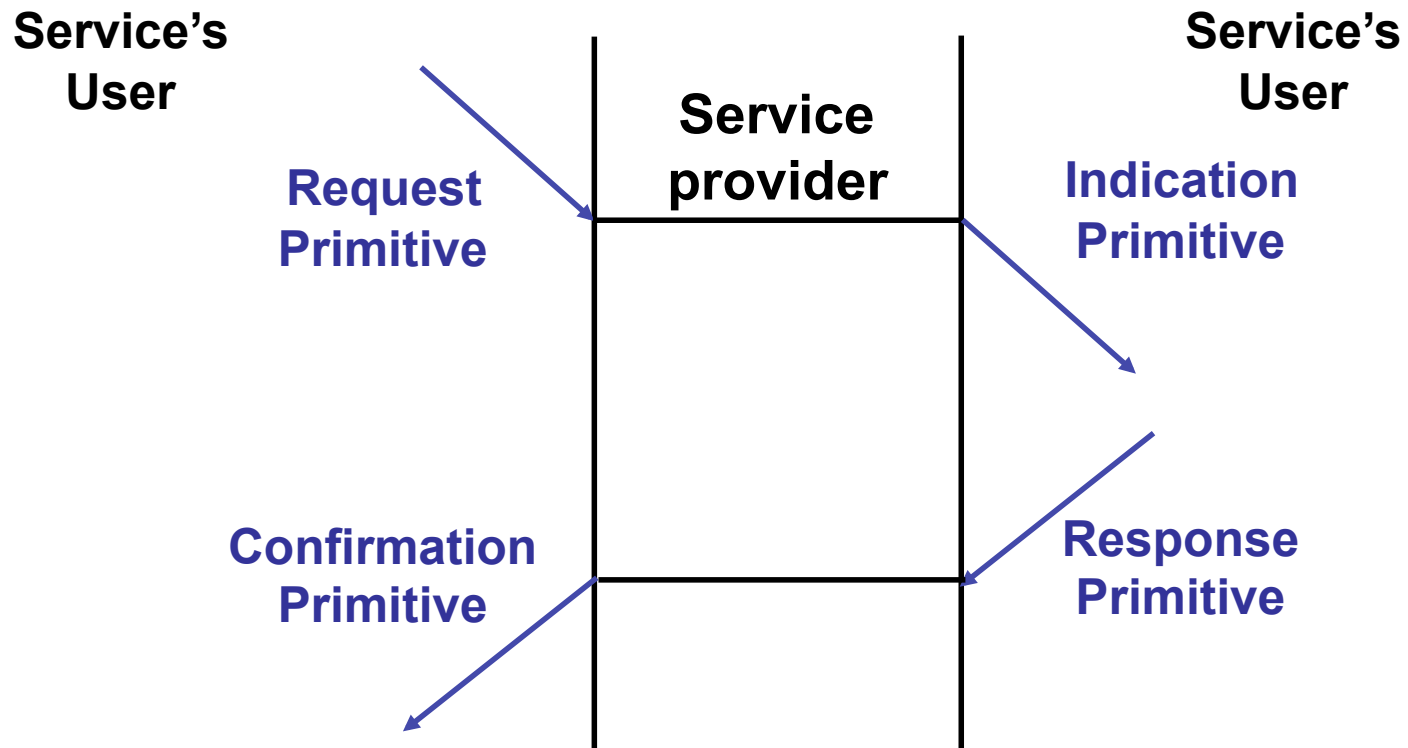



Primitives' Use

Un-Confirmed Service

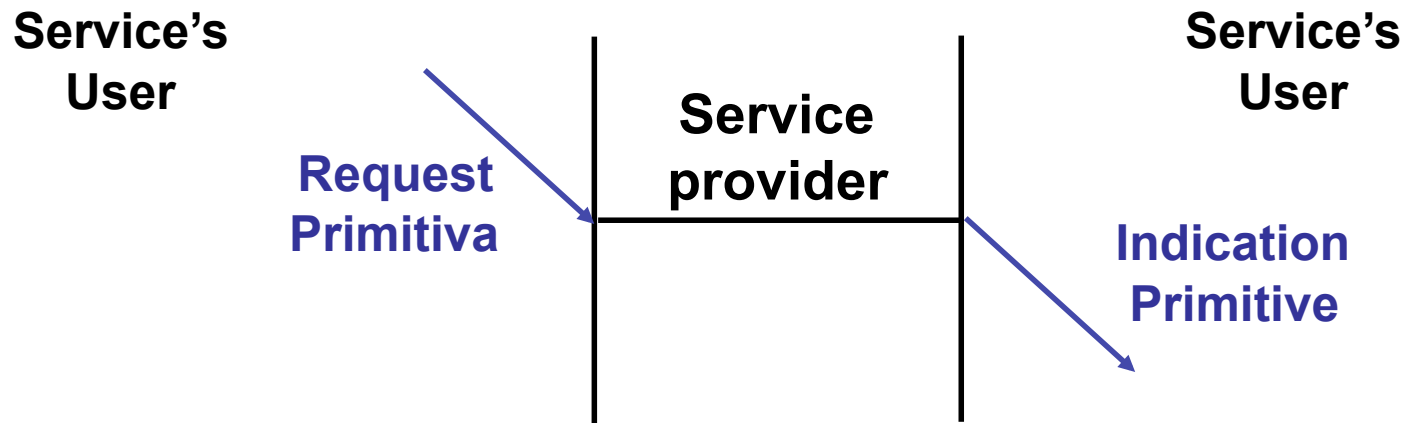



Primitives' Use

Service Provider Initiated

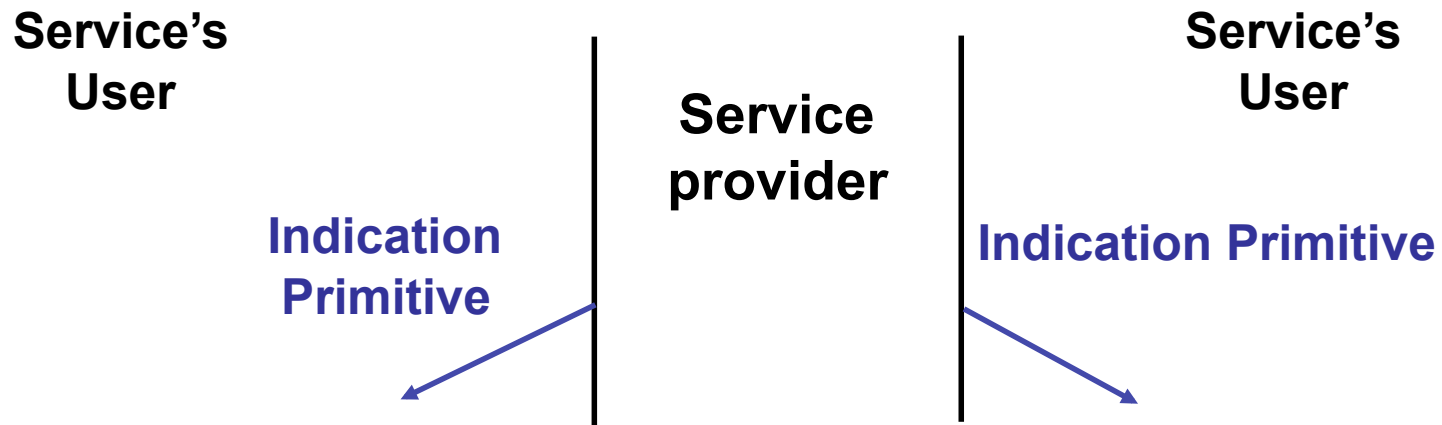

Nomadic Communications & WLANs

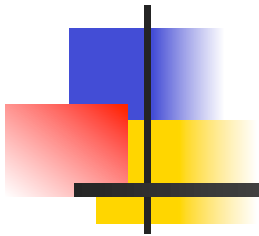

characterized by LAN-like wireless access
typically use Internet upper layers
requires some means to handle portability and (sometimes)
local mobility



LAN Protocols

- Standardization process started in the '80s by IEEE 802 project:
 - ✓ 802.1: LAN *Internetworking*
 - ✓ 802.2: LLC Sublayer
 - ✓ 802.3: CSMA/CD: *Ethernet* is a small (1-bit in the header) variation of 802.3
 - ✓ 802.4: *Token Bus*
 - ✓ 802.5: *Token Ring*
 - ✓ 802.6: DQDB (for MANs)

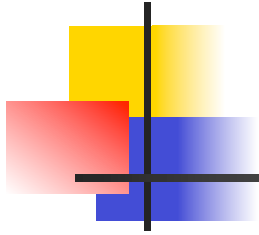

LAN Protocols

- Work is still going on in many technical committees and new committees are founded every year (or close to):
 - ✓ 802.7: Broadband Technical Advisory Group
 - ✓ 802.8: Fiber-Optic Technical Advisory Group
 - ✓ 802.9: Integrated Data and Voice Networks
 - ✓ 802.10: Network Security
 - ✓ **802.11: Wireless Networks (/a/b/g/h/f/s/n/p/...)**
 - ✓ 802.12: 100base VG
 - ✓ 802.13: 100base X
 - ✓ **802.15: Personal Area Networks (.1 [Bluetooth]4 (ZigBee))**
 - ✓ **802.16: Wireless MAN (WiMax & Co.)**
 - ✓ ...