

Nomadic Communications

802.11e – Service Differentiation



UNIVERSITÀ DEGLI STUDI DI TRENTO

Renato Lo Cigno
LoCigno@disi.unitn.it - Tel: 2026

Dipartimento di Ingegneria e Scienza dell'Informazione

Home Page: <http://isi.unitn.it/locigno/index.php/teaching-duties/nomadic-communications>

Copyright

Quest'opera è protetta dalla licenza:

Creative Commons
Attribuzione-Non commerciale-Non opere derivate
2.5 Italia License

Per i dettagli, consultare
<http://creativecommons.org/licenses/by-nc-nd/2.5/it/>



locigno@disi.unitn.it

2



Quality-of-Service Provisioning:
Some Terminology

- **Definition:** A **flow** is a packet stream from a source to a destination, belonging to the same application
- **Definition:** **QoS** is a set of service requirements to be met by the network while transporting a flow
- Typical QoS metrics include: available bandwidth, packet loss rate, estimated delay, packet jitter, hop count and path reliability

locigno@disi.unitn.it

3



QoS in Wireless Networks

- QoS schemes in wired networks are NOT suitable for wireless networks
 - e.g., current wired-QoS routing algorithms require accurate link state and topology information
 - time-varying capacity of wireless links, limited resources and node mobility make maintaining accurate information difficult
- Supporting QoS in wireless networks is an even more difficult challenge

locigno@disi.unitn.it 4

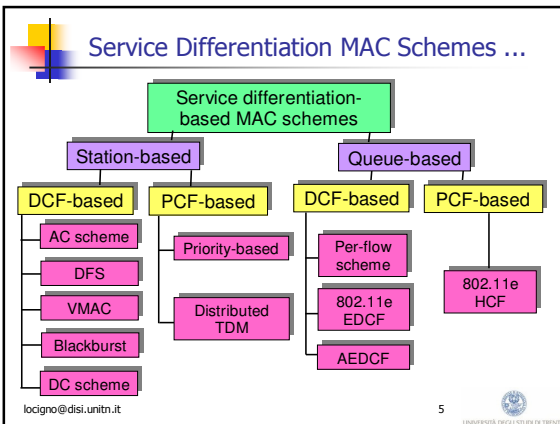

A QoS Standard for WLANs: IEEE 802.11e

- The IEEE 802.11 TG E was formed in 1999
- The Project Authorization Request (PAR) was approved in March 2000
- **Scopes of the IEEE 802.11 Task Group E**
 - Enhance the current 802.11 MAC to improve and manage QoS
 - Consider efficiency enhancements in the areas of DCF and PCF
 - Provide different classes of service (4 TCs)

locigno@disi.unitn.it 6

802.11e Standard

- Released 2007
- PHY unchanged (use a/b/g)
- MAC Enhanced: Goals
 - Traffic Differentiation and Guarantee
 - TSPEC and CAC
 - Interoperation with legacy 802.11
- Will be the base for the next evolution: 802.11n

locigno@disi.unitn.it 7 

802.11e: QSTA, QAP, QBSS, HCF

- A station using 802.11e is called *QoS Enhanced Station (QSTA)*
- An AP using 802.11e is called *QoS Access Point (QAP)*
- QSTA e QAP works within a *QoS Basic Service Set (QBSS)*
- The two coordination functions DCF e PCF are substituted by a single *Hybrid Coordination Function (HCF)*

locigno@disi.unitn.it 8 

TXOPs

- **TXOP: Transmission Opportunity**
 - Time interval during which a QSTA has the right to transmit
 - It is characterized by a starting time and a maximum duration (TXOP_Limit)
 - Used in both CP and CFP

locigno@disi.unitn.it 9 

802.11e Coordination Function

- Hybrid Coordination Function, alternates:
 - EDCA (Enhanced Distributed Channel Access), contention based, conceived to support legacy stations and provide some *stochastic* level of differentiation
 - HCCA (HCF Coordinated Channel Access), polling based, provides collision free periods with guaranteed assignment and *deterministic* differentiation

locigno@disi.unitn.it 10 

802.11e QoS Mechanisms

802.11e proposes a new access scheme: **Hybrid Coordination Function (HCF)**, composed of two coordination functions

- Enhanced Distributed Channel Access (EDCA)
 - A basis layer of 802.11e; operates in CP
- HCF Controlled Channel Access (HCCA)
 - HCCA operates in CFP

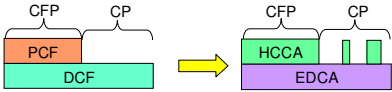

locigno@disi.unitn.it 11 

802.11e QoS Mechanisms

- MAC-level FEC (Hybrid I and II)
- Ad hoc features:**
 - Direct Communication / Side Traffic
 - WARP: Wireless Address Resolution Protocol
 - AP mobility

locigno@disi.unitn.it 12 

802.11e: Hybrid Coordinator

- Within a QBSS a centralized controller is needed to coordinated all QSTAs. This is the *Hybrid Coordinator* (HC), normally implemented within a QAP
- An HC has the role of splitting the transmission superframe in two phases continuously alternating:
 - Contention Period* (CP), where QSTAs content for the channel using EDCA
 - Contention-Free Period* (CFP), where HC defines who is going to use the channel and for what time with a collision free polling protocol

locigno@disi.unitn.it 13 

MAC 802.11e: HCCA

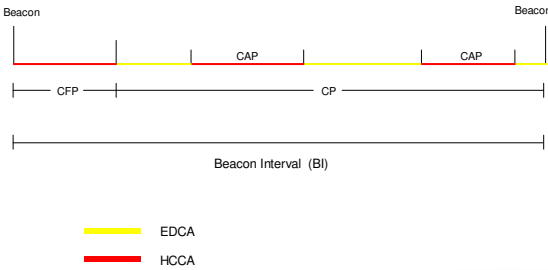

locigno@disi.unitn.it 14 

802.11e: EDCF

- The *Enhanced Distributed Coordination Function* (EDCF) define a differentiated access scheme based on an improved (yet complex) contention scheme
- It is an evolution of CSMA/CA DCF, with the add-on of traffic classes to support QoS and differentiate traffic
- EDCF is designed to support frames with the same 8 priority levels of 802.1d, but mapping them on only 4 access categories
- Every frame passed to the MAC layer from above, must have a priority identifier (from 0 to 7), called *Traffic Category Identification* (TCId)

locigno@disi.unitn.it 15 

802.11e: EDCF

- TCId is written in one header field of the MAC frame
- Each 802.11e QSTA & QAP MUST have four separated AC queues
- Each AC queue is FIFO and behaves independently from the others as far as the CSMA/CA MAC protocol is concerned

locigno@disi.unitn.it 16

802.11e: EDCF

locigno@disi.unitn.it 17

802.11e: EDCF

- ACs are differentiated based on their CSMA parameters:
 - **IFS**
 - **CWmin**
 - **CWmax**
 - **Backoff exponent**

locigno@disi.unitn.it 18

802.11e: EDCF

- Higher priority ACs are assigned parameters that result in shorter CWs so that a statistical advantage is gained in accessing the channel
- Protocol parameters become vectors
 - CWmin[AC]
 - CWmax[AC]
 - AIFS[AC]
 - bck[AC]
- CW[AC,t] is derived with the usual CSMA/CA rules

locigno@disi.unitn.it 19

802.11e: EDCF

- Arbitration InterFrame Space (AIFS) substitute the common DIFS
- Each AIFS is at least DIFS long
- Befor entering the backoff procedure each *Virtual Station* will have to wait AIFS[AC], instead of DIFS

locigno@disi.unitn.it 20

Arbitration IFS (AIFS)

802.11a: slot=9 μs, SIFS=6 μs, PIFS=15 μs, DIFS=24 μs, AIFS ≥34 μs

locigno@disi.unitn.it 21

Contention Window

- $CW_{\min}[AC]$ and $CW_{\max}[AC]$
- Contention Window update:

$$CW_{new}[AC] = (CW_{old}[AC] + 1) \cdot bck - 1$$

locigno@disi.unitn.it 22

Backoff

802.11a: slot=9 μs, SIFS=16 μs, PIFS=25 μs, DIFS=34 μs, AIFS ≥34 μs

locigno@disi.unitn.it 23

Virtual Stations

- Each AC queue behaves like a different **virtual station** (independent sensing and backoff)
- If the backoff counters of two or more parallel ACs in the same QSTA reach 0 at the same time, a scheduler inside the QSTA avoids collision by **granting the TXOP** to the AC with the highest UP
- **The lowest priority colliding behaves as if there were an external collision**

locigno@disi.unitn.it 24

802.11e: EDCF – Beacon Frames

- Values of AIFS[AC], CWmin[AC] e CWmax[AC] are determined by the QAP and transmitted within beacon frames (normally every 100 msec)
- QSTAs must abide to the received parameters
- QSTAs may use these parameters to chose the QAP the prefer to connect to (estimate of the expected performance)

locigno@disi.unitn.it 25 

802.11e: TXOP

- TXOP is the time interval in which a STA may use the channel
- It's an initial time plus a duration, indeed the contention is no more for a PDU, but can be for many aggregated PDUs
- CW[AC] is managed with usual rules of increment (after collisions/failures) and decrement (during idle cahnnel):

$$\text{NewCW[AC]} = ((\text{OldCW[AC]} + 1) * 2) - 1$$

locigno@disi.unitn.it 26 

802.11e: EDCF

- Sample allocation of TCid to ACs:

TCID	CA	Traffic description
0	0	Best Effort
1	0	Best Effort
2	0	Best Effort
3	1	Video Probe
4	2	Video
5	2	Video
6	3	Voice
7	3	Voice

locigno@disi.unitn.it 27 



EDCA Bursting

- Once the station has gained access to the medium, it can be allowed to send **more than one frame** without contending again
- The station cannot transmit longer than **TXOP_Limit**
- ACK frame by frame or Burst ACK**
- SIFS** is used between frames within the same TXOP to maintain the channel control when assigned

locigno@disi.unitn.it 28 



EDCA Bursting: Pros / Cons

- Pros**
 - Reduces network **overhead**
 - Increases throughput** (SIFS and burst ACKs)
 - Better fairness** among the same priority queues: independently of the frame size, a QSTA gets a TXOP every time it wins a contention
 - E.g., STA A uses 500 B frame; STA B uses 1K B frame. Thus B would get higher throughput in 802.11, while in 802.11e both can get approximately same throughput

locigno@disi.unitn.it 29 



EDCA Bursting: Pros / Cons

- Cons**
 - Possible increasing of **delay jitter**
 - TXOP_Limit should be longer than the time required for transmitting the largest data frame at the minimum speed
- In any case EDCA does not solve the downlink/uplink unfairness problem

locigno@disi.unitn.it 30 

802.11e: HCF

- HC may allocate TXOPs to himself (QAP) or to other QSTAs
- Self allocation is done to transmit MSDUs, allocation of resources may solve the uplink/downlink unfairness
- Allocation to AP can be done after a Point coordination InterFrame Space (PIFS) con $PIFS < DIFS$
- HC (QAP) has priority over other stations and may interrupt a CP to start a CFP transmitting a Poll frame

locigno@disi.unitn.it 31 

802.11e: HCF

- Time is divided between contention free periods (CFP) and contention periods (CP), that are alternated roughly cyclically
- A sequence CFP + CP defines a Periodic Superframe of 802.11e
- The CP can be interrupted by other contention free periods called CAPs

locigno@disi.unitn.it 32 

802.11e: HCF

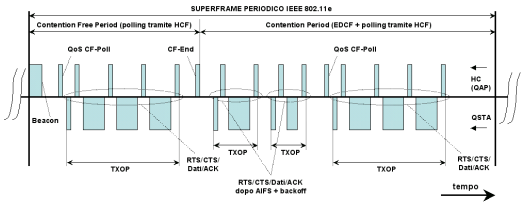

locigno@disi.unitn.it 33 

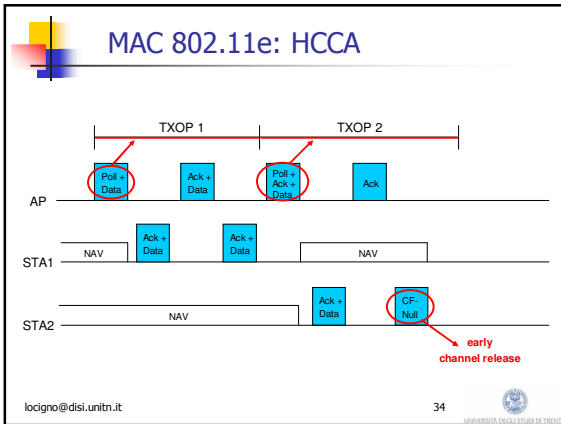

- ### 802.11e: HCF – QoS CFPoll Frame
- Within a CP, TXOP is determined either:
 - Through EDCF rules (free channel + AIFS + BO + TXtime)
 - Through a poll frame, called QoS CFPoll, sent by HC to a station
 - QoS CFPoll is sent after PIFS, so with priority wrt any other traffic
 - Indeed there is not a big difference between a CFP and CAPs
 - During CFP, TXOPs are again determined by HC and QoS CFPoll can be piggybacked with data and ACKs if needed
 - Stations not polled set NAV and cannot access the channel
- locigno@disi.unitn.it 35

- ### 802.11e: HCF – QoS CFPoll Frame
- The CFP must terminate within a time specified in beacons and it is terminated by the CF-End frame sent by HC
 - QoS CF-Poll frame was introduced with the 802.11e amendment, for backward compatibility it contains a NAV field the legacy stations can use to avoid interfering
 - NAV specify the whole TXOP duration
 - Legacy stations in HCF can only use the CP period
- locigno@disi.unitn.it 36



HCCA

- HCCA effectively provides policing and deterministic channel access by controlling the channel through the HC
- It is backward compatible with basic DCF/PCF
- Based on polling of QSTAs by the HC

locigno@disi.unitn.it 37 



HCCA

Crucial features of HCCA

- HCCA operates in CP and CFP
- Uses TXOPs which are granted through HC (in HCCA!)
 - HC allocates TXOPs by using QoS CF-Poll frames
 - In CPs, the time interval during which TXOPs are polled by HC is called CAP (Controlled Access Period)
 - 8 Traffic Categories (TCs)

locigno@disi.unitn.it 38 



HC Behavior in HCCA

- According to HCCA:
 - HC may allocate TXOPs to itself to transmit MSDUs whenever it wants, however only after having sensed the channel idle for PIFS
 - In CP, the HC can send the CF-Poll frame after a PIFS idle period, thus starting a CAP
 - In CFP, only the HC can grant TXOPs to QSTAs by sending the CF-Poll frame
 - The CFP ends after the time announced by HC in the beacon frame or by the CF-End frame from HC

locigno@disi.unitn.it 39 

QSTA Behavior in HCCA

- A QSTA behaves as follows
 - In CP QSTAs can gain a TXOP thanks to a CF-Poll frame issued by HC during CAPs, otherwise they can use EDCA
 - In CFP, QSTAs do not attempt accessing the channel on their own but wait for a CF-Poll frame from the HC
- The HC indicates the TXOP duration to be used in the CF-Poll frame (QoS-control field)
 - Legacy stations kept silent by NAV whenever they detect a CF-Poll frame

locigno@disi.unitn.it 40

802.11e Superframe

The diagram illustrates the structure of an 802.11e periodic superframe, divided into two main phases: Contention Free Period (CFP) and Contention Period (CP).

- Contention Free Period (CFP):** This phase begins with a beacon frame. It contains a sequence of QoS CF-Poll frames (red bars) and TXOPs (green bars) for QSTAs. The CFP ends with a CF-End frame. A DATA/ACK frame is shown as being polled by the HC.
- Contention Period (CP):** This phase starts after a backoff period (DIFS+backoff). It begins with an RTS/CTS/DATA/ACK frame. This is followed by QoS CF-Poll frames (red bars) and TXOPs (green bars) for QSTAs. The CP concludes with a DATA/ACK frame and a TX by HC frame.

During the CP, a TXOP may begin because:

- The medium is determined to be available under EDCA rules (EDCA-TXOP)
- The STA receives a special polling frame from HC (polled-TXOP)

time

Polling in HCCA

- Polling list is a crucial key in HCCA
 - Traffic scheduling (i.e., how QSTAs are polled) is not specified
 - QSTAs can send updates to the HC on their queue size as well as on the desired TXOP, (through the QoS control field in data frames)
 - QSTAs can send ADDTS requests to initiate a new traffic stream

locigno@disi.unitn.it 42

Traffic Signaling

- Two types of signaling traffic are supported:
 - Connectionless queue state indicator
 - E.g., Arrival rate measurement: notification and not negotiation between peer entities is used
 - TSPEC (Traffic Specification) between HC and QSTAs
 - E.g., service negotiation and resource reservation

locigno@disi.unitn.it 43

Traffic Signaling

- TSPEC are the base for CAC
- QoS without CAC is impossible
- QoS is granted to flows not to packets
- Flows are persistent (normally)
- Flows can be predicted (sometimes)

locigno@disi.unitn.it 44

Resource Scheduling

- Not essential to backward compatibility
 - The standard has just a reference impl. (SS)
- HCF is implemented in the AP
 - HCCA scheduling is a function of HCF
- Requirements of traffic flows are contained in the *Traffic Specifications* (TSPEC):
 - Maximum, minimum and mean datarate
 - Maximum and nominal size of the MSDUs
 - Maximum Service Interval and **Delay Bound**
 - Inactivity Interval
 - ...

locigno@disi.unitn.it 45



EDCA Differentiation HCCF Scheduling

Renato Lo Cigno
www.disi.unitn.it/locigno/didattica/NC/



...Copyright

Quest'opera è protetta dalla licenza *Creative Commons NoDerivs-NonCommercial*. Per vedere una copia di questa licenza, consultare:
<http://creativecommons.org/licenses/nd-nc/1.0/>
oppure inviare una lettera a:
Creative Commons, 559 Nathan Abbott Way, Stanford, California 94305, USA.

This work is licensed under the *Creative Commons NoDerivs-NonCommercial* License. To view a copy of this license, visit:
<http://creativecommons.org/licenses/nd-nc/1.0/>
or send a letter to
Creative Commons, 559 Nathan Abbott Way, Stanford, California 94305, USA.

locigno@disi.unitn.it 47 



Thanks & Disclaimer

- These slides and results are based on the following paper
 - "Performance Evaluation of Differentiated Access Mechanisms Effectiveness in 802.11 Networks", Ilenia Tinnirello, Giuseppe Bianchi, Luca Scalia, IEEE Globecomm 2004.
- As such they must be considered examples of the possible performances and tradeoffs
- Thanks to Bianchi and all the other authors for providing copy of the papers graphics and slides

locigno@disi.unitn.it 48 



EDCA or HCCA?

- How does EDCA support differentiation?
- Is this enough for standard purposes?
- Are parameters easy to tune and universal?

- How can HCCA polling-based scheduling be implemented?
- Do we need to use the feedback from the STA?
- How can the traffic be described?

locigno@disi.unitn.it 49 



Performance Evaluation of Differentiated Access Mechanisms Effectiveness in 802.11 Networks

G. Bianchi, I. Tinnirello, L. Scalia

presented @ Globecom 2004



QoS Support issues in legacy 802.11

- DCF is long term fair
 - Equal channel access probability among the stations
 - Averagely, the same channel holding time (for homogeneous packet sizes)
 - Solution: differentiate packet sizes?
 - Solution: differentiate channel holding times?
- NO WAY! QoS is not a matter of how long I hold the channel
 - It means more...
 - Need to manage access delay problems for real-time apps!!!
 - Need to modify 802.11 channel access fairness!!!

locigno@disi.unitn.it 51 

QoS @ IEEE 802.11 MAC

- 802.11e defines different traffic classes onto map data flows
- Each traffic class behaves as an independent MAC entity
- Differentiated access priority is provided by:
 - Giving probabilistically lower backoff counters (**CWmin**, **CWmax**, **PF**)
 - Giving deterministically lower inter-frame spaces and backoff de-freezing times. (**AIFSN**)

EDCA

Different MAC Access Parameters @ each class to differentiate channel access probability

Backoff based parameters: **CWmin**, **CWmax**, **PF**
 Channel monitoring based parameters: **AIFS**

Virtual Collision Handler (manage internal collisions)
 Grants TXOP to highest priority class

Transmission attempt

locigno@disi.unitn.it 52

EDCA Performance Evaluation

- Performance Evaluation: answers we try to give...
 - Homogeneous sources
 - Performance effectiveness of each differentiation MAC parameter, individually taken
 - How each differentiation parameter reacts to different load conditions?
 - Heterogeneous sources
 - What are the most effective settings to manage high-priority delay requirements?

locigno@disi.unitn.it 53

EDCA Performance Evaluation

- Simulations
 - Same number of HP and LP stations
 - Same packet size (1024 bytes)
- Homogeneous sources scenario
 - Saturation conditions for HP and LP stations
 - Queues never empty
 - Data rate = Phy rate = 1 Mbps
- Heterogeneous sources scenario
 - 3 pkts/sec. for HP traffic
 - Saturation conditions for LP traffic
 - Data rate = Phy rate = 1 Mbps

locigno@disi.unitn.it 54

CWmax Differentiation (1)

- $CW_{max}(A) < CW_{max}(B)$
 - Once reached CW_{max} (repeated collisions), A gets access priority over B

A extracts probabilistically a lower backoff value due to its lower CW_{max}

locigno@disi.unitn.it 55

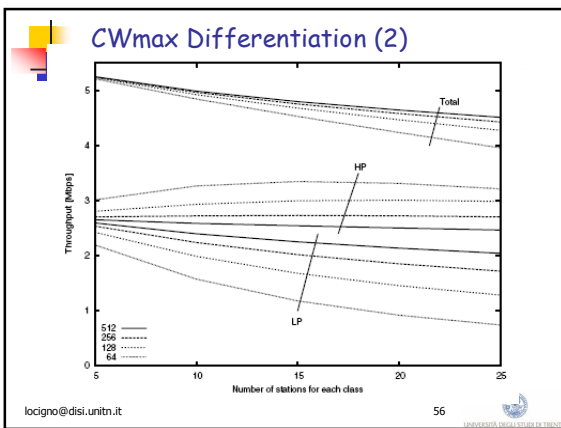

CWmax Differentiation (3)

- Low throughput differentiation
 - Only with $CW_{max}=64$ effective
 - @ low loads poor performance
 - Few collisions
- Inefficient channel usage
 - Consecutive Collisions are needed for the differentiation effect
 - Overall throughput suffers @ high loads

locigno@disi.unitn.it 57

PF Differentiation (1)

- PF(A) < PF(B)
 - once a collision occurs, station A has probabilistically an higher chance to extract a lower backoff value, thus it may retransmits first.

A extracts probabilistically a lower backoff value due to its lower CW

locigno@disi.unitn.it 58

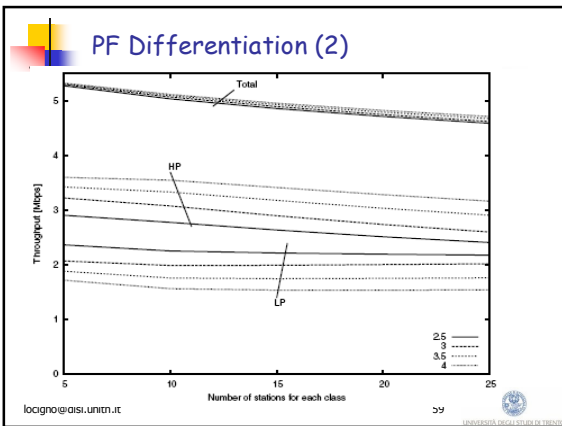

PF Differentiation (3)

- PF is greater than 2 for LP stations.
- $CW_{new} = PF * CW_{old}$
- It is sufficient a single collision to begin the differentiation process.
- Impossible to force LP traffic to zero!
 - After a packet successful transmission, the PF effect is no more present

locigno@disi.unitn.it 60

CWmin Differentiation (1)

- $CWmin(A) < CWmin(B)$
 - In average, station A has a lower backoff than B

A

B

Thanks to its lower CWmin, A extracts probabilistically a lower backoff value

locigno@disi.unitn.it 61

CWmin Differentiation (2)

locigno@disi.unitn.it 62

CWmin Differentiation (3)

- Very good differentiation performance
- @ low loads performance is good
 - Collision effects among HPs not significant
- @ high loads collisions mainly involve HP stations (because of their small CW)
 - Degradations regard HP traffic -> bad!
 - LP traffic not affected
 - Collision effects un-altered

locigno@disi.unitn.it 63

AIFS Differentiation (1)

- AIFS(A) < AIFS(B)
 - station A decrements its backoff timer before than station B

Thanks to its lower AIFS, A starts decrementing its backoff value before than B either after busy channel or idle channel conditions

locigno@disi.unitn.it 64

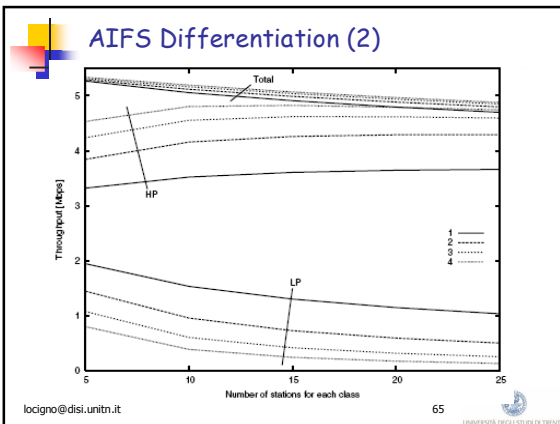

AIFS Differentiation (3)

- Very High differentiation performance
 - Complementary to CWmin case
- @ low loads differentiation performance suffers
 - Collision are few ->
- @ high loads collisions mainly involve LP stations, since HP stations access first
 - Degradations regard LP traffic -> good!
 - HP traffic not affected

locigno@disi.unitn.it 66

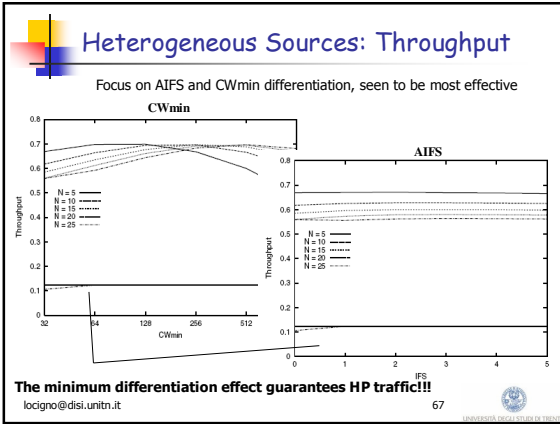

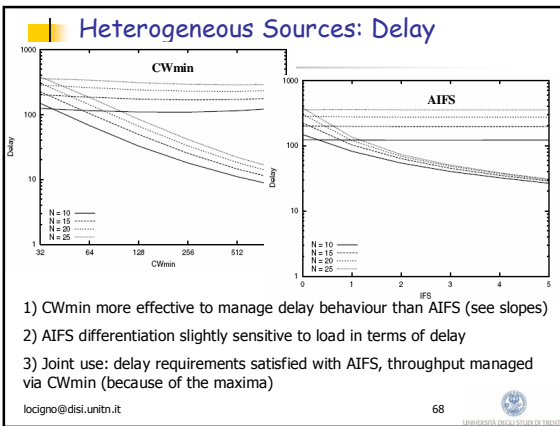

- ### Conclusions
- CWmin and AIFS differentiation perform better than PF and CWmax differentiation
 - PF and CWmax differentiation operations allowed only by collisions
 - CWmin and AIFS show a complementary behaviour
 - CWmin performance degrades @ high loads
 - AIFS performance degrades @ low loads
 - Joint use of CWmin and AIFS
 - AIFS to meet delay requirements
 - CWmin to manage throughput performance
 - Complex parameter setting
 - Behavior hardly predictable
- locigno@disi.unitn.it 69

Scheduling in HCCA: Sample Open and Close-Loop Schedulers

- ### Outline
- Scheduling: The Rules of The Game
 - Sample (on the standard) Scheduler
 - Equivalent Bandwidth Approach
 - Closed Loop Scheduling: A Control Theoretic Approach
- locigno@disi.unitn.it 71 

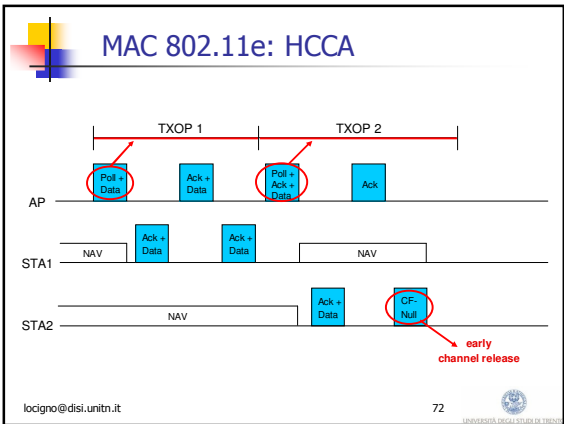

Resource Scheduling (2)

- KEY notions are
 - Service Interval - SI(j): The maximum amount of time between successive polling to a station j
 - Transmission Opportunities - TXOP(j): The amount of resources (time) assigned to station j in a single polling
- Goals of scheduling:
 - Find suitable values of SIs and TXOPs
 - Fully exploit resources
 - Guarantee quality and differentiation of the TSPECs

locigno@disi.unitn.it 73

Reference Implementation (SS)

Service Interval $m = \min_i(\text{MaximumServiceInterval}_i)$

$SI = \max(x) \text{ t.c. } x < m \text{ e } BI \bmod x = 0$

TXOP $N_i = \left\lceil \frac{SI \times \rho_i}{L_i} \right\rceil$

$T_i = \max\left(\frac{N_i \times L_i}{R} + O, \frac{M_i}{R} + O\right)$

ρ_i Mean datarate
 L_i Nominal MSDU size
 M_i Maximum MSDU size
 R TX rate
 O Overhead (Ack, SIFS,...)

locigno@disi.unitn.it 74

Feedback Information ... or not?

- SS Schedules is open-loop:
 - Uses only TSPEC info
 - Assigns the mean rate: not suited for VBR ...
 - ... but you can assign a rate based on an **Equivalent Bandwidth** approach
- 802.11e has a field to feedback information about backlog (bytes or frames in queue)
 - Use this info for prediction or
 - Use this info for **closed-loop control**?

locigno@disi.unitn.it 75

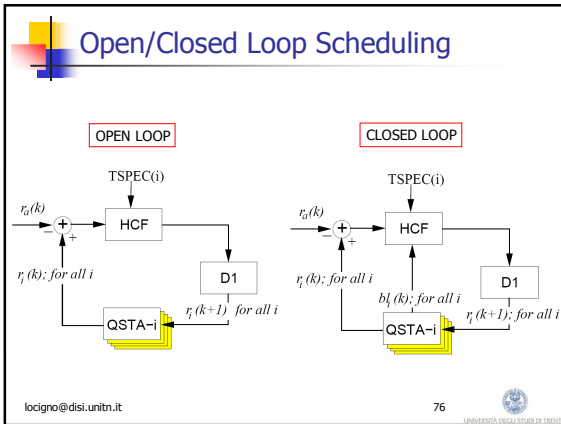

Equivalent Bandwidth

- Well known approach
 - Conceptually simple, just assign resources such that

$$P\left[\frac{\rho}{SI} > \frac{EB(p)}{SI}\right] = p$$

- EB(p) is the assignment that guarantees p frame loss probability
- ρ is the actual (time-dependent) offered traffic
- But ...** requires full stochastic knowledge of the traffic ☹

locigno@disi.unitn.it 77

Closed-loop Scheduling: Basics

- Discrete time modeling
 - Just throw away time (creates a lot of problems)
 - The system evolves in cycles of SIs: 1,2,3,...,k
- Goal: equalize (to zero) all queues
- Max/Min fair approach
 - Only resources above the minimum guarantee are "controlled"
- Assumption: There is a CAC function ensuring long-term stability
 - Can use large loop gains without oscillation risks

locigno@disi.unitn.it 78

 Closed-loop Scheduling: Formulae

$$\frac{1}{K} \sum_{k=1}^K r_a(k) > \sum_{i=1}^{N_{QS}} \bar{r}_i$$

CAC based long term stability:
the average available resources
over a finite time K are larger
than the average assigned resources

$$r_j(k) = r_j^{\min}(k) + r_j^+(k)$$

$$r_j^+(k+1) = \frac{B_j(k)}{\sum_{j=1}^{N_{TS}} B_j(k)} \left[r_a(k+1) - \sum_{j=1}^{N_{TS}} r_j^{\min}(k+1) \right]$$

locigno@disi.unitn.it 79 

 Closed-loop Scheduling: Formulae

$$\frac{1}{K} \sum_{k=1}^K r_a(k) > \sum_{i=1}^{N_{QS}} \bar{r}_i$$

Max/Min Fairness
 r^{\min} are guaranteed
and not subject to control
 r^+ is strictly non negative

$$r_j(k) = r_j^{\min}(k) + r_j^+(k)$$

$$r_j^+(k+1) = \frac{B_j(k)}{\sum_{j=1}^{N_{TS}} B_j(k)} \left[r_a(k+1) - \sum_{j=1}^{N_{TS}} r_j^{\min}(k+1) \right]$$

locigno@disi.unitn.it 80 

 Closed-loop Scheduling: Formulae

$$\frac{1}{K} \sum_{k=1}^K r_a(k) > \sum_{i=1}^{N_{QS}} \bar{r}_i$$

Simple proportional controller
splitting excess resources
among all the flows that are
backlogged

$$r_j(k) = r_j^{\min}(k) + r_j^+(k)$$

$$r_j^+(k+1) = \frac{B_j(k)}{\sum_{j=1}^{N_{TS}} B_j(k)} \left[r_a(k+1) - \sum_{j=1}^{N_{TS}} r_j^{\min}(k+1) \right]$$

locigno@disi.unitn.it 81 

Details ... the real doom!

- Highly quantized resource assignment
 - A minimum assignment of one maximum size segment is mandatory ... what if the station transmits at low rate?
 - "Fragments" of frames might lead to waste resources
- Reaction of the controller can be sluggish

In the worst case the response time is about 2*SI

locigno@disi.unitn.it 82

Closed-loop Schedulers

- MMF-A
 - Implements the formulae above
 - Have quantization and response problems
- MMF-AR
 - Dynamically changes the SI 'on-demand' 😊
 - Reassign spare resources at the end of the CFP
 - Violates proportional assignment to avoid quantization problems

locigno@disi.unitn.it 83

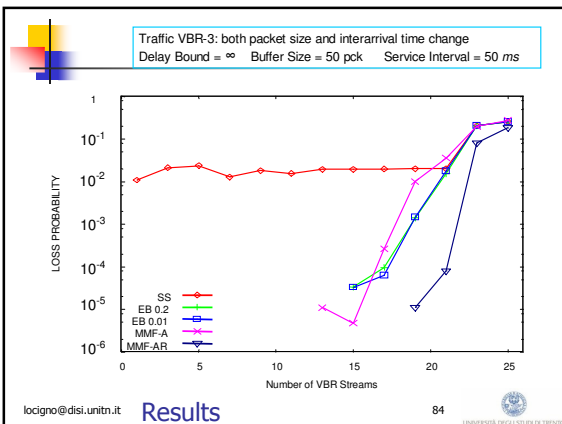

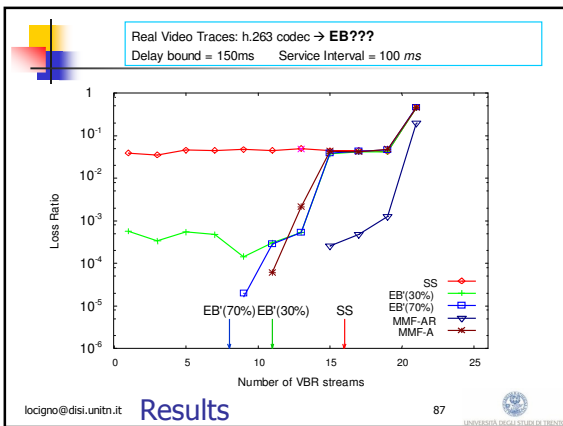
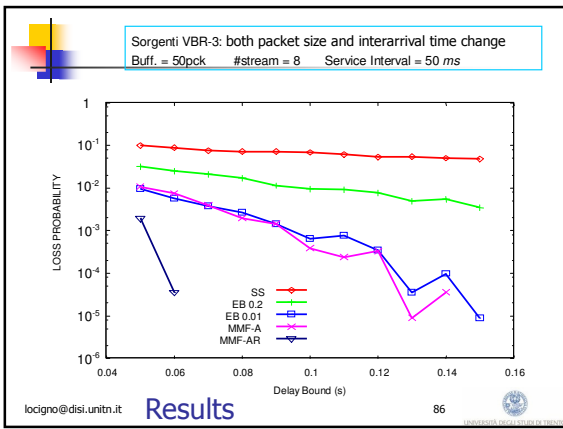
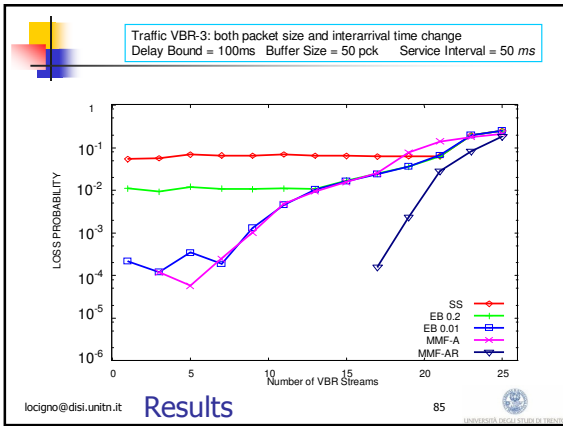



Conclusions

- Different HCCA scheduling explored
- HCCA complexity is manageable, performances are better than EDCA, configuration is easier
- Closed-loop scheduling:
 - Viable alternative to open-loop or predictive scheduling
 - Complexity much simpler and effective than Equivalent Bandwidth approaches
- The BIG problem are details
 - Quantization, Normalization, Spare Resource Collection, ...

locigno@disi.unitn.it

88



UNIVERSITÀ DEGLI STUDI DI TRENTO
