

Nomadic Communications

WLAN (802.11)



UNIVERSITÀ DEGLI STUDI DI TRENTO

Renato Lo Cigno
LoCigno@disi.unitn.it - Tel: 2026

Dipartimento di Ingegneria e Scienza dell'Informazione

Home Page: <http://isi.unitn.it/locigno/index.php/teaching-duties/nomadic-communications>



Copyright

Quest'opera è protetta dalla licenza:

Creative Commons
Attribuzione-Non commerciale-Non opere derivate
2.5 Italia License

Per i dettagli, consultare
<http://creativecommons.org/licenses/by-nc-nd/2.5/it/>



locigno@disi.unitn.it 2 



IEEE 802.11

- Wireless LAN standard specifying a wireless interface between a client and a base station (or access point), as well as between wireless clients
- Defines the PHY and MAC layer (LLC layer defined in 802.2)
- Physical Media: radio or diffused infrared
- Standardization process begun in 1990 and is still going on (1st release '97, 2nd release '99, then '03, '05, ...)

locigno@disi.unitn.it 3 

802.11 Architecture

- BSS (Basic Service Set): set of nodes using the same coordination function to access the channel
- BSA (Basic Service Area): spatial area covered by a BSS (WLAN cell)
- BSS configuration mode
 - ad hoc mode
 - with infrastructure: the BSS is connected to a fixed infrastructure through a centralized controller, the so-called Access Point (AP)

locigno@disi.unitn.it 4 

WLAN with Infrastructure

- BSS contains:
 - wireless hosts
 - access point (AP): base station
- BSS's interconnected by distribution system (DS)

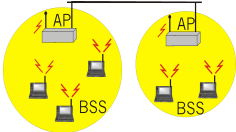

locigno@disi.unitn.it 5 

Ad Hoc WLANs

- Ad hoc network: IEEE 802.11 stations can dynamically form a network *without AP* and communicate directly with each other: IBSS Independent BSS
- Applications:
 - "laptop" meeting in conference room, car
 - interconnection of "personal" devices
 - battlefield
- IETF MANET (Mobile Ad hoc Networks) working group



locigno@disi.unitn.it 6 

Extended Service Set (ESS)

- Several BSSs interconnected with each other at the MAC layer
- The backbone interconnecting the BSS APs (Distribution System) can be a:
 - LAN (802.3 Ethernet/802.4 token bus/802.5 token ring)
 - wired MAN
 - IEEE 802.11 WLAN, possibly meshed (routing problems!)
- An ESS can give access to the fixed Internet network through a gateway node
 - If fixed network is a IEEE 802.X, the gateway works as a bridge thus performing the frame format conversion

locigno@disi.unitn.it 7 

Possible Scenarios (1)

Ad hoc networking
Independent BSS (IBSS)

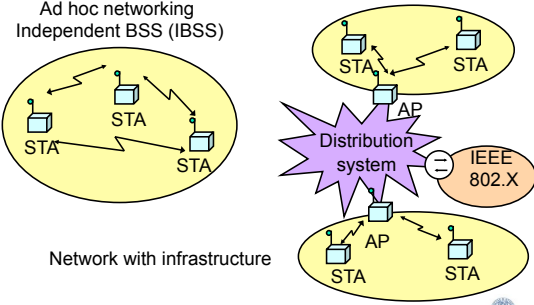

Network with infrastructure

locigno@disi.unitn.it 8 

Possible Scenarios (2)

Ad hoc WLAN

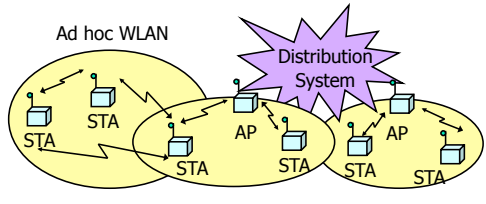

WLANs with infrastructure

locigno@disi.unitn.it 9 

Joining a BSS

```

    graph LR
      Scanning[Scanning] --> Authentication[Authentication]
      Authentication --> Association[Association]
  
```

- BSS with AP: Both authentication and association are necessary for joining a BSS
- Independent BSS: Neither authentication neither association procedures are required for joining an IBSS

locigno@disi.unitn.it 10

Joining BSS with AP: Scanning

A station willing to join a BSS must get in contact with the AP. This can happen through:

- 1. Passive scanning**
 - The station scans the channels for a Beacon frame that is periodically (100ms) sent by every AP
- 2. Active scanning (the station tries to find an AP)**
 - The station sends a ProbeRequest frame
 - All AP's within reach reply with a ProbeResponse frame

- Active Scanning may be more performant but waste resources

locigno@disi.unitn.it 11

Passive Scan

- Beacons are broadcast frames transmitted periodically (default 100ms). They contain:
 - Timestamp
 - TBTT (Target Beacon Transmission Time) – also called Beacon Interval
 - Capabilities
 - SSID (BSSID is AP MAC address + 26 optional octets)
 - PHY layer information
 - System information (Network, Organization, ...)
 - Information on traffic management if present
 - ...
- STA answer to beacons with a ProbeResponse containing the SSID

locigno@disi.unitn.it 12



Active Scan

- **Directed probe:** The client sends a probe request with a specific destination SSID; only APs with a matching SSID will reply with a probe response
 - It is often considered "secure" if APs do not broadcast SSIDs and only respond to Directed Probes ...
- **Broadcast probe:** The client sends a null SSID in the probe request; all APs receiving the probe-request will respond with a probe-response for each SSID they support
 - Useful for service discovery systems

locigno@disi.unitn.it 13 



Joining BSS with AP: Authentication

Once an AP is found/selected, a station goes through authentication

- **Open system authentication** (default, 2-step process)
 - Station sends authentication frame with its identity
 - AP sends frame as an ack / nack
- **Shared key authentication**
 - Stations receive shared secret key through secure channel independent of 802.11
 - Stations authenticate through secret key (requires encryption via WEP)
- **Per Session Authentication (WPA2 – more later)**

locigno@disi.unitn.it 14 



Joining BSS with AP: Association

Once a station is authenticated, it starts the association process, i.e., information exchange about the AP/station capabilities and roaming

- **STA → AP:** AssociateRequest frame
- **AP → STA:** AssociationResponse frame
- New AP informs old AP via DS
- Only after the association is completed, a station can transmit and receive data frames

locigno@disi.unitn.it 15 



IEEE 802.11 MAC Protocol

Performs the following functions:

- Resource allocation
- Data segmentation and reassembly
- MAC Protocol Data Unit (MPDU) address
- MPDU (frame) format
- Error control

locigno@disi.unitn.it 16 



MAC Frames

Three frame types are defined

- 1. Control:** positive ACK, handshaking for accessing the channel (RTS, CTS)
- 2. Data Transfer:** information to be transmitted over the channel
- 3. Management:** connection establishment/release, synchronization, authentication. Exchanged as data frames but are not reported to the higher layer

locigno@disi.unitn.it 17 



Data Transfer

- Asynchronous data transfer for delay-tolerant traffic (like file transfer)
 - **DCF** (Distributed Coordination Function)
- Synchronous data transfer for real-time traffic (like audio and video)
 - **PCF** (Point Coordination Function): based on the polling of the stations and controlled by the AP (PC)
 - Its implementation is optional (not really implemented)

locigno@disi.unitn.it 18 



Coordination

- The system is semi-synchronous
 - Maintained through Beacon frames (sent by AP)
- Time is counted (when needed) in intervals, called **slots**
- A slot is the system unit time
 - its duration depends on the implementation of the physical layer
 - 802.11b: **20μs**; 802.11a: **9 μs**

locigno@disi.unitn.it 19 



IFS

- Interframe space (IFS)
 - time interval between frame transmissions
 - used to establish priority in accessing the channel
- 4 types of IFS:
 - Short IFS (SIFS)
 - Point coordination IFS (PIFS) >SIFS
 - Distributed IFS (DIFS) >PIFS
 - Extended IFS (EIFS) > DIFS
- Duration depends on physical level implementation

locigno@disi.unitn.it 20 



Short IFS (SIFS)

- **To separate transmissions belonging to the same dialogue**
- Associated to the highest priority
- Its duration depends on:
 - Propagation time over the channel
 - Time to convey the information from the PHY to the MAC layer
 - Radio switch time from TX to RX mode
- 802.11b: 10μs; 802.11a: 16 μs

locigno@disi.unitn.it 21 

 **Point Coordination IFS (PIFS)**

- Used to give priority access to Point Coordinator (PC)
- Only a PC can access the channel between SIFS and DIFS
- $PIFS = SIFS + 1$ time slot

locigno@disi.unitn.it 22 

 **Distributed IFS (DIFS)**

- Used by stations waiting for a free channel to contend
- Set to: $PIFS + 1$ time slot
- 802.11b: $50\mu s$; 802.11a: $34\mu s$

locigno@disi.unitn.it 23 

 **Extended IFS (EIFS)**

- Used by every station when the PHY layer notifies the MAC layer that a transmission has not been correctly received
- Avoids that stations with bad channels disrupt other stations' performance
- Forces fairness in the access is one station does not receive an ACK (e.g. hidden terminal)
- Reduce the priority of the first retransmission (indeed make it equal to all others)
- Set to: $DIFS + 1$ ACK slot

locigno@disi.unitn.it 24 



DCF Access Scheme

locigno@disi.unitn.it 25 



Basic Characteristics

- Its implementation is mandatory
- DCF is based on the Carrier Sense Multiple Access/Collision Avoidance (CSMA/CA) scheme:
 - stations that have data to transmit contend for accessing the channel
 - a station has to repeat the contention procedure every time it has a data frame to transmit

locigno@disi.unitn.it 26 



IEEE 802.11 MAC Protocol Overview: CSMA/CA

802.11 CSMA: sender
 - if sense channel idle for **DISF** sec.
 then transmit entire frame (no collision detection)
 -if sense channel busy
 then random access over a contention window CWmin (CA)

802.11 CSMA receiver:
 if received OK
 return ACK after **SIFS**

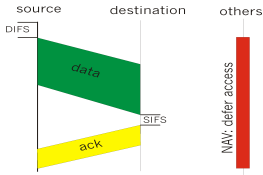

locigno@disi.unitn.it 27 

IEEE 802.11 MAC Protocol Overview

802.11 CSMA Protocol: others

- NAV: Network Allocation Vector
 - 802.11 frame has transmission time field
 - others (hearing data) defer access for NAV time units
 - NAV is contained in the header of frames
 - Allows reducing energy consumption
 - Helps reducing hidden terminals problems

locigno@disi.unitn.it 28

Hidden Terminal Effect

- hidden terminals: A, C cannot hear each other
 - obstacles, signal attenuation
 - collisions at B
- goal: avoid collisions at B
- CSMA/CA with handshaking

locigno@disi.unitn.it 29

IEEE 802.11 MAC Protocol Overview: Handshaking

- CSMA/CA: explicit channel reservation
 - sender: send short RTS: request to send
 - receiver: reply with short CTS: clear to send
- CTS reserves channel for sender, notifying (possibly hidden) stations
- avoid hidden station collisions

locigno@disi.unitn.it 30

IEEE 802.11 MAC Protocol Overview: Handshaking

- RTS and CTS are short:
 - collisions of shorter duration, hence less "costly"
 - the final result is similar to collision detection
- DCF allows:
 - CSMA/CA
 - CSMA/CA with reservations

source destination others

DIFS RTS CTS data ack

NAV timer access

locigno@disi.unitn.it 31 UNIVERSITÀ DEGLI STUDI DI TRENTO

The DCF Access Scheme

- Basic**
 - the simplest scheme
 - used when the data frames to be transmitted have a fairly short duration
- With handshaking**
 - Uses additional control frames for channel access
 - Designed to solve the problems of hidden terminals
 - Provides higher reliability in data transmission

locigno@disi.unitn.it 32 UNIVERSITÀ DEGLI STUDI DI TRENTO

The exposed terminal problem

- Sensing range is normally larger than receiving range
- Terminals may be "exposed" in that they sense the channel occupied, but cannot compete for it

CS range TX range

bla bla bla

locigno@disi.unitn.it 33 UNIVERSITÀ DEGLI STUDI DI TRENTO



DCF
The Basic Access Mode

locigno@disi.unitn.it 34  UNIVERSITÀ DEGLI STUDI DI TRENTO



Carrier Sensing

- Used to determine whether the channel is busy or idle
- Performed at the physical layer (physical carrier sensing) and at the MAC layer (virtual carrier sensing)
 - **Physical carrier sensing:** detection of nearby energy sources
 - **Virtual carrier sensing:** the frame header indicates the remaining duration of the current Channel Access Phase (till ACK is received)

locigno@disi.unitn.it 35  UNIVERSITÀ DEGLI STUDI DI TRENTO



Network Allocation Vector (NAV)

- Used by the stations nearby the transmitter to store the duration of the frame that is occupying the channel
- The channel will become idle when the NAV expires
- Upon the NAV expiration, stations that have data to transmit listen to the channel again

locigno@disi.unitn.it 36  UNIVERSITÀ DEGLI STUDI DI TRENTO



Using DIFS and SIFS

- **Transmitter:**
 - senses the channel
 - if the channel is idle, it waits a time equal to DIFS
 - if the channel remains idle for DIFS, it transmits its MPDU

locigno@disi.unitn.it 37 



Using DIFS and SIFS

- **Receiver:**
 - computes the checksum thus verifying whether the transmission is correct
 - if so, it sends an ACK after a time equal to SIFS
 - it should always transmit an ACK with a rate less than or equal to the one used by the transmitter and no larger than
 - 2 Mbit/s in 802.11b
 - 6/12 Mbit/s in 802.11g/a/h

locigno@disi.unitn.it 38 



Using DIFS and SIFS

- **Neighbors:**
 - set their NAV to the value indicated in the transmitted MPDU
 - NAV set to: the MPDU tx time + 1 SIFS + ACK time

locigno@disi.unitn.it 39 

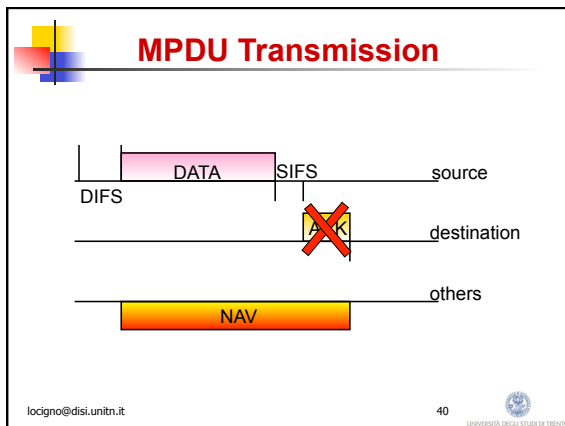

- ### Frame Retransmissions
- A frame transmission may fail because of collision or errors on the radio channel
 - A failed transmission is re-attempted till a max no. of retransmissions is reached
 - ARQ scheme: Stop&Wait
- locigno@disi.unitn.it 41

- ### Collision Avoidance (CA)
- Backoff procedure**
- If a station senses the channel busy, it waits for the channel becoming idle
 - As soon as the channel is idle for DIFS, the station
 - computes the backoff time interval
 - sets the backoff counter to this value
 - The station will be able to transmit when its backoff counter reaches 0
- locigno@disi.unitn.it 42

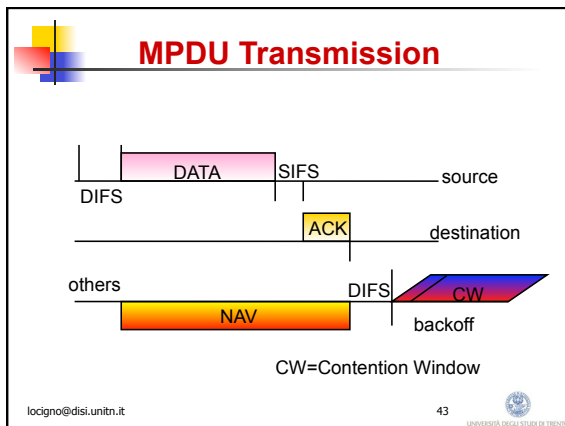

- ### Backoff Value
- Integer value corresponding to a number of time slots
 - The number of slots is a r.v. uniformly distributed in $[0, CW-1]$
 - CW is the Contention Window and at each transmission attempt is updated as:
 - For $i=1$, $CW_1 = CW_{min}$
 - For $i > 1$, $CW_i = 2CW_{i-1}$ with $i > 1$ being the no. of consecutive attempts for transmitting the MPDU
 - For any i , $CW_i \leq CW_{max}$
- locigno@disi.unitn.it 44

- ### Backoff Decrease
- While the channel **is busy**, the backoff counter **is frozen**
 - While the channel is idle, and available for transmissions the station decreases the backoff value (-1 every slot) until
 - the channel becomes busy or
 - the backoff counter reaches 0
- locigno@disi.unitn.it 45

Accessing the Channel

- If more than one station decrease their counter to 0 at the same time → collision
- Colliding stations have to recompute a new backoff value

locigno@disi.unitn.it 46 

Basic DCF: An Example

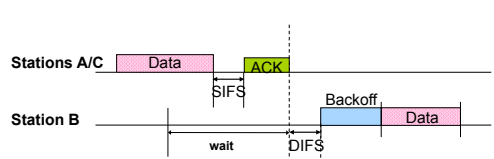

Stations A/C: Data, ACK

Station B: wait, Backoff, Data

Intervals: SIFS, DIFS

locigno@disi.unitn.it 47 

Data Fragmentation (1)

- A MSDU is fragmented into more than one frame (MPDU) when its size is larger than a certain **fragmentation threshold**
 - In the case of failure, less bandwidth is wasted
- All MPDUs have same size except for the last MPDU that may be smaller than the fragmentation threshold
- PHY header is inserted in every fragment → convenient if the fragmentation threshold is not too little

locigno@disi.unitn.it 48 



Data Fragmentation (2)

- MPDUs originated from the same MSDU are transmitted at distance of SIFS + ACK + SIFS
- The transmitter releases the channel when
 - the transmission of all MPDUs belonging to a MSDU is completed
 - the ACK associated to an MPDU is lost

locigno@disi.unitn.it 49 



Data Fragmentation (3)

- Contention Window (Backoff counter) is increased for each fragment retransmission belonging to the same frame
- The receiver reassembles the MPDUs into the original MSDU that is then passed to the higher layers
- Broadcast and multicast data units are never fragmented

locigno@disi.unitn.it 50 



Recontending for the Channel

- A station recontends for the channel when
 - it has completed the transmission of an MPDU but still has data to transmit
 - a MPDU transmission fails and the MPDU must be retransmitted
- **Before recontending the channel after a successful transmission, a station must perform a backoff procedure with CWmin**

locigno@disi.unitn.it 51 



DCF Access with handshaking

locigno@disi.unitn.it 52 



Access with Handshake

- Used to reserve the channel
- Why?
 - Hidden stations
 - Colliding stations keep transmitting their MPDU; the larger the MPDU involved in the collision, the more bandwidth is wasted
 - Need to avoid collisions, especially when frame is large
 - Particularly useful when a large no. of STAs contend for the channel

locigno@disi.unitn.it 53 



RTS/CTS

- Handshaking procedure uses the Request to send (RTS) and Clear to send (CTS) control frames
- RTS / CTS should be always transmitted @1 (6a/g/h) Mbit/s (they are only headers)
- Access with handshaking is used for frames larger than an RTS_Threshold

locigno@disi.unitn.it 54 

DCF with Handshaking

- **Transmitter:**
 - send a RTS (20 bytes long) to the destination
- **Neighbors:**
 - read the duration field in RTS and set their NAV
- **Receiver:**
 - acknowledge the RTS reception after SIFS by sending a CTS (14 bytes long)
- **Neighbors:**
 - read the duration field in CTS and update their NAV
- **Transmitter:**
 - start transmitting upon CTS reception

locigno@disi.unitn.it 55

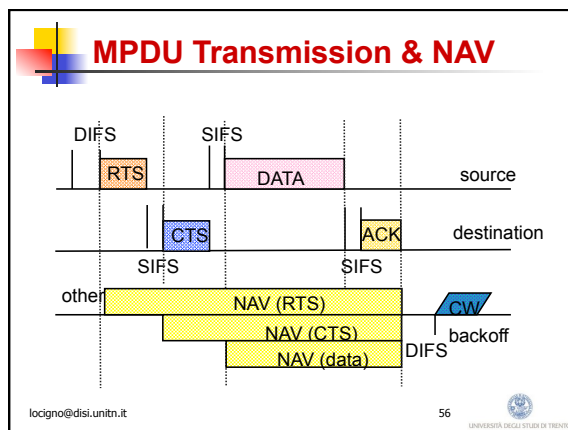

Examples of frame format

locigno@disi.unitn.it 57

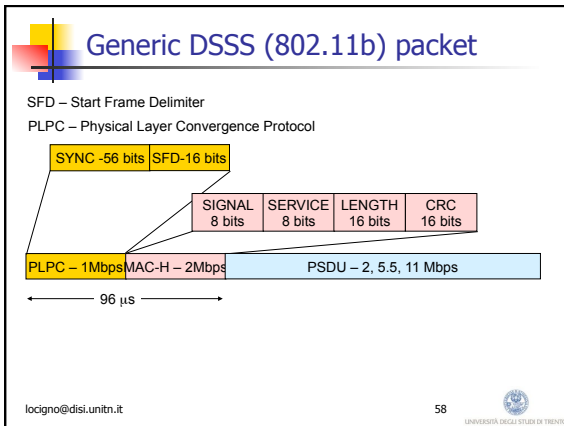

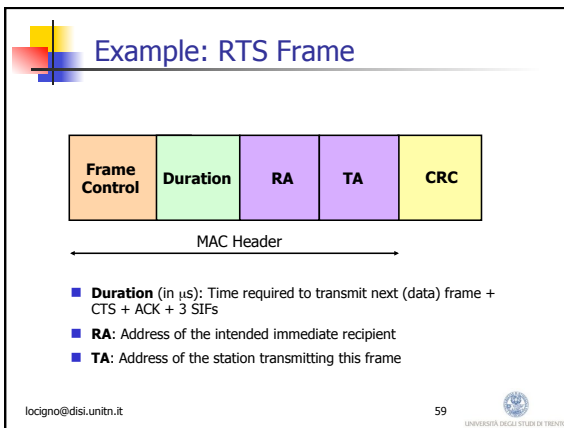

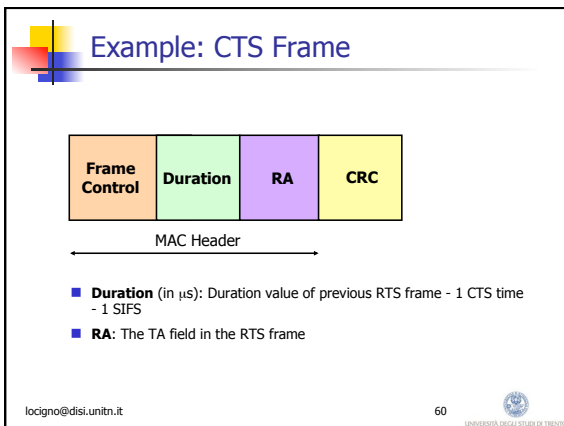

Example: ACK Frame

- **Duration**: set to 0 if More Fragments bit was 0, otherwise equal to the duration of previous frame - 1 ACK - 1 SIFS
- **RA**: copied from the Address 2 field of previous frame

locigno@disi.unitn.it 61

Some Numerical Values...

- PHY_{HDR} : 16 bytes, transmitted @ 1 Mbps
- MAC_{HDR} : 34 bytes, transmitted @ 1 Mbps
 - If slot=20 μ s, $PHY_{HDR} + MAC_{HDR} = 20$ slots
- $ACK = PHY_{HDR} + 14$ bytes, transmitted @ 1 Mbps
 - If slot=20 μ s, $ACK = 12$ slots

locigno@disi.unitn.it 62

Detailed MAC Format (bytes)

Frame Control	Duration ID	Address1 (source)	Address2 (destination)	Address3 (rx node)
2	2	6	6	6

Sequence Control	Address4 (tx node)	Data	FCS
2	6	0 - 2,312	4

locigno@disi.unitn.it 63



MAC Format fields

Field	Bits	Notes/Description
Frame Control	15 - 14	Protocol version. Currently 0
	13 - 12	Type
	11 - 8	Subtype
	7	To DS. 1 = to the distribution system.
	6	From DS. 1 = exit from the Distribution System.
	5	More Frag. 1 = more fragment frames to follow (last or unfragmented frame = 0)
	4	Retry. 1 = this is a re-transmission.
	3	Power Mgt. 1 = station in power save mode, 0 = active mode.
	2	More Data. 1 = additional frames buffered for the destination address (address x).
	1	WEP. 1 = data processed with WEP algorithm. 0 = no WEP.
	0	Order. 1 = frames must be strictly ordered.

locigno@disi.unitn.it 64 



MAC Format fields

Field	Bits	Notes/Description
Duration ID	15 - 0	For data frames = duration of frame. For Control Frames the associated identity of the transmitting station.
Address 1	47 - 0	Source address (6 bytes).
Address 2	47 - 0	Destination address (6 bytes).
Address 3	47 - 0	Receiving station address (destination wireless station)
Sequence Control	15 - 0	
Address 4	47 - 0	Transmitting wireless station.
Frame Body		0 - 2312 octets (bytes).
FCS	31 - 0	Frame Check Sequence (32 bit CRC). defined in P802.11.

locigno@disi.unitn.it 65 